

# OBZOR

switches & outlets

---

**technical  
catalog**

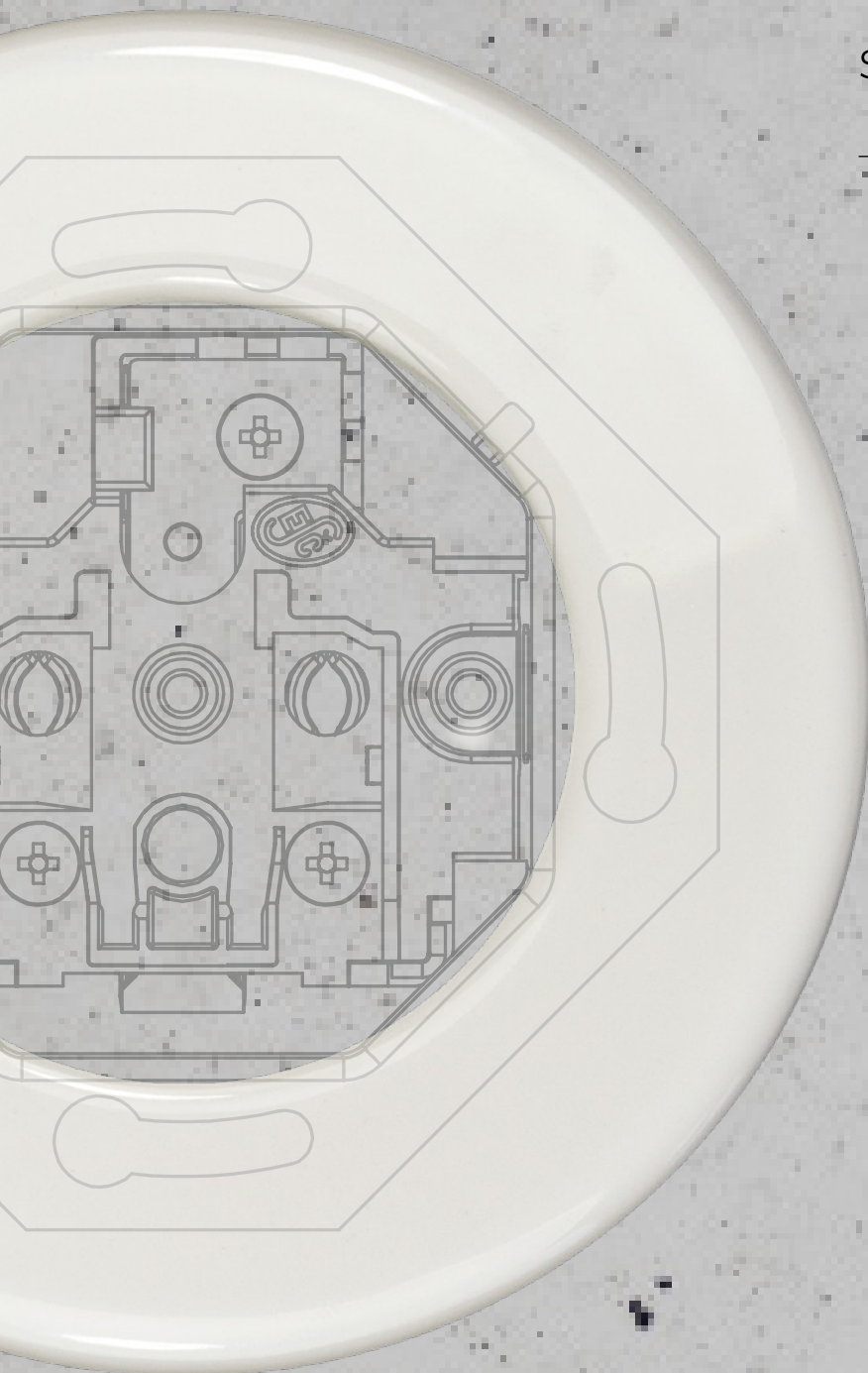

# assembling of fittings – composition of order code

In case of demand of a single frame set, fittings can be specified by a composite assembly code with following definition:

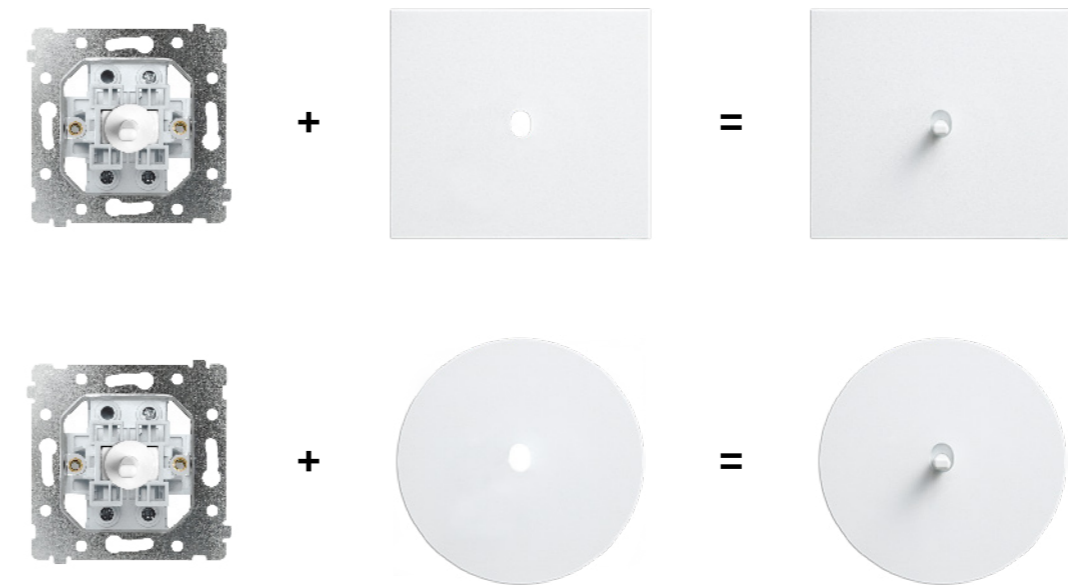
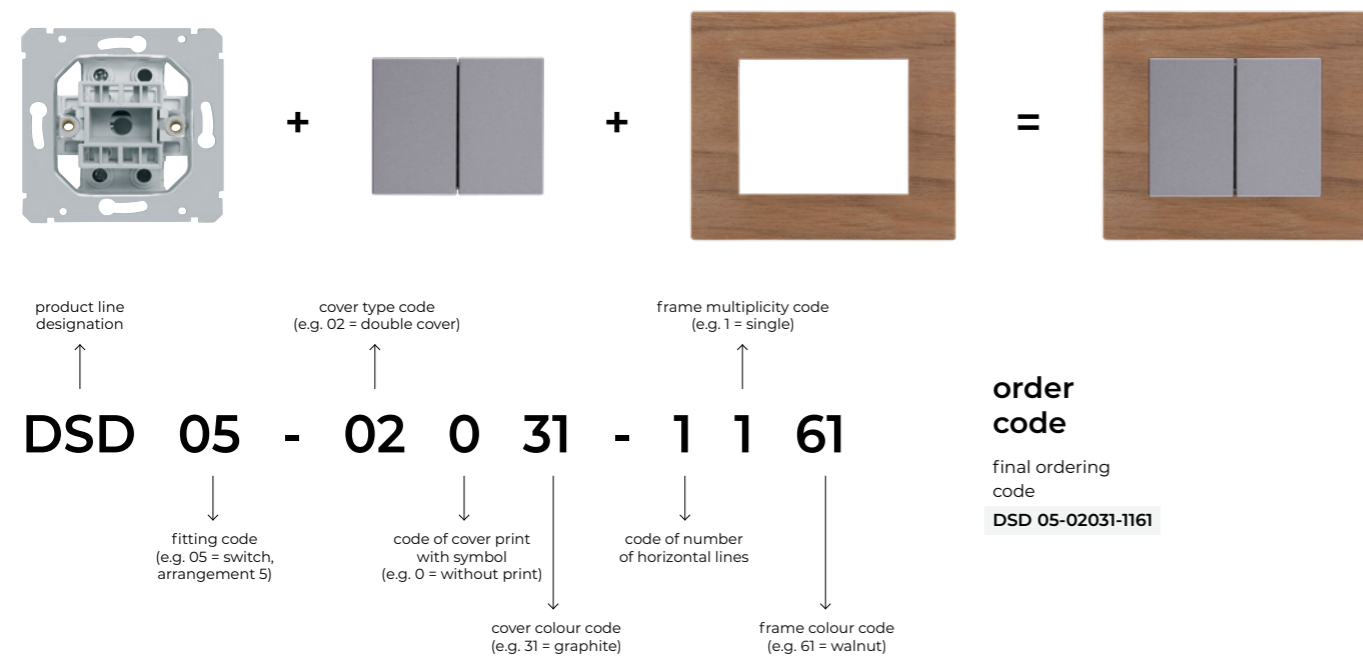
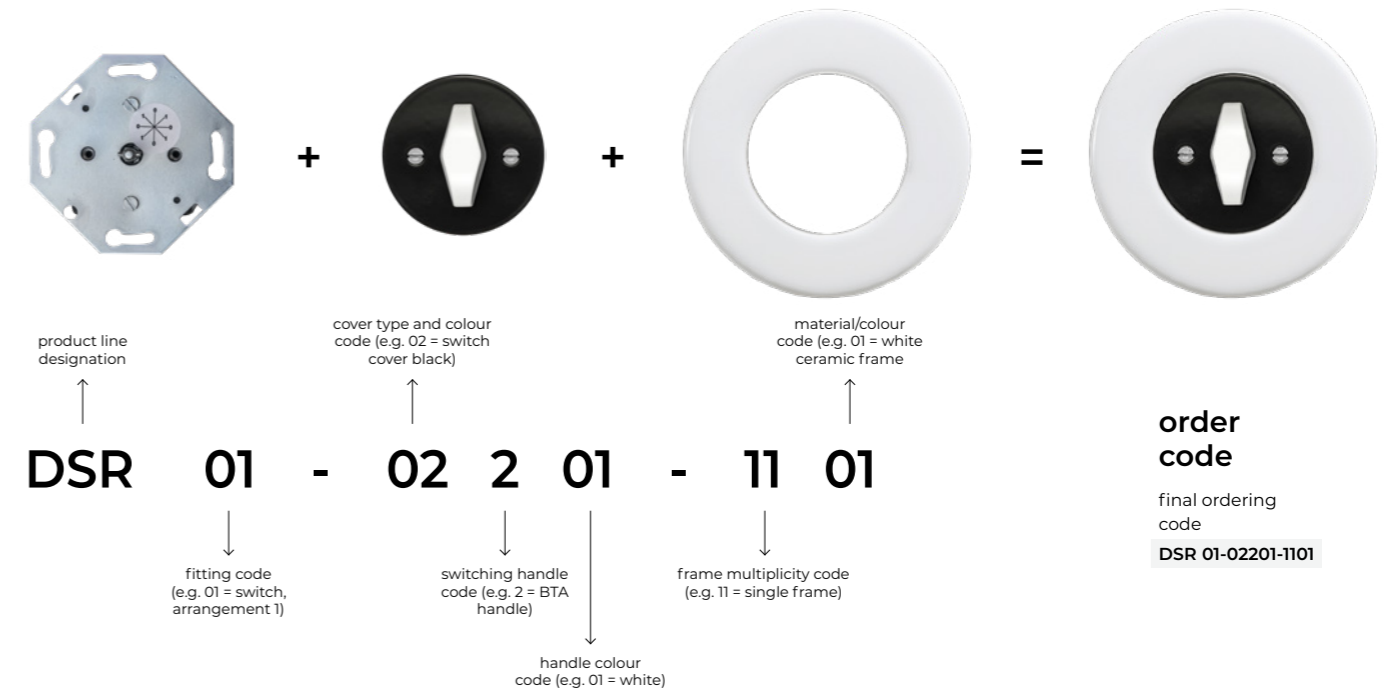
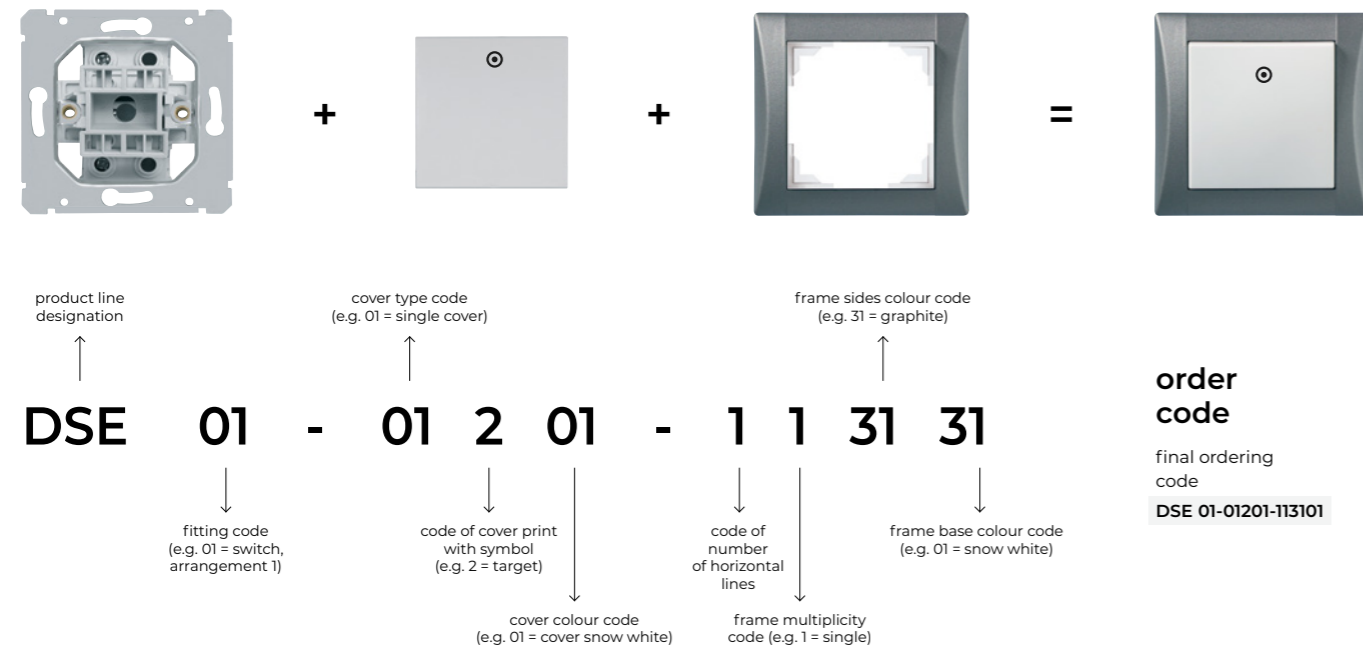

VECTIS and VECTIS ROUND fittings and frames need to be ordered separately as there is no possibility to create codes for sets.



We'll be always glad to help you with your specification and order.  
In case of any questions please do not hesitate to contact our sales department,, tel.: +420 577 195 151 or e-mail: [odbyt@obzor.cz](mailto:odbyt@obzor.cz).

# OBZOR

switches & outlets  
made in Czech Republic

## content

about us .....	6
retro .....	9
decente .....	25
decente audio modules .....	35
decente hotel systems .....	37
decente smart home .....	39
vectis .....	41
vectis round .....	47
elegant .....	53
elegant aqua IP 44 .....	65
madera wall mounted IP 44 house switches .....	66
elegant vacuum outlets .....	69
elegant medical .....	71
variant .....	75
thermostats and motion sensors .....	85
accessories .....	88
wiring diagrams.....	90
technical drawings .....	92

# obzor at your fingertips

## ... tradition since 1965

OBZOR company was founded over fifty years ago. During this time the company has established among the top manufacturers and distributors of small electromechanical products, automotive parts, metal and injection moulding parts. Year 2000 can be considered as the beginning of development and subsequent production of wiring products such as switches, outlets, drivers and more.



- a company with more than fifty years of tradition 100% Czech owned
- stability and quality
- traditional Czech manufacturer of cam switches, house wiring and accessories
- major supplier of plastic parts for automotive
- top equipment
- assembly of products
- socially responsible company

## product lines

### elegant / since 2003

A product line of classic, unobtrusive design that offers wide range of colours and combinations. Unique frame design, which allows to combine two colours together - on the side and base frame segment. An unusual design for joining frames can also create vertical, modular or up to seven times horizontal combinations.

- product features**
- switches, outlets, controllers
  - aqua outlets and switches with IP 44 protection
  - medical series outlets for healthcare industry
  - vacuum outlets
  - thermostats, PIR sensors
  - short-press switches for smart home systems

### variant / since 2009

Product line of courageous and playful design. Distinctive rich frame colours always attract attention and have an optimistic feel. Variant series uses same covers and fittings as Elegant which makes it easy in case you want to upgrade the design of your switches (up to triple horizontal combination).

- product features**
- switches, outlets, controllers
  - thermostats, PIR sensors

### decente / since 2011

This timeless product line uses natural noble materials – glass, wood, metal, concrete and plexiglass. These prime frames can be combined up to four-fold horizontal and vertical. In 2014–2015, Decente range has expanded with new glass frame colours, matt frames, and more affordable PLEXIGLASS version in white or black.

- product features**
- switches, outlets, controllers
  - thermostats, PIR sensors
  - short-press switches for smart home systems
  - data outlets
  - DECENTE hotel systems
  - DECENTE audio modules

### retro / since 2017

Switches of RETRO line feature an original design inspired by rotary switches from the 1930s and unique functionalist architecture of Zlín city. Round frames are made of solid wood, ceramics, glass or concrete and are also available in horizontal / vertical double or triple versions. Switches are unusually controlled by a handle. They are suitable not only for rustic, but also for minimalist and industrial interiors. RETRO series contains wide range of fittings according to current standards for a comfortable living.

- product features**
- switches, outlets, controllers
  - data outlets

### vectis, vectis round by ISD / since 2020

We are also introducing two brand new minimalist series, developed in partnership with ISD company. VECTIS, sober in shape and colour, is characterized by an atypical design and control: a single panel of solid aluminum with a decent toggle. VECTIS is available in multiple frames up to fourfold horizontal and vertical.

- product features**
- switches, outlets, controllers
  - data outlets



# retro

*i am not discrete...  
i am a jewel...*



New range of RETRO switches and outlets is introducing an original design inspired by combination of rotary ceramic switches from the time of 1930 ´s and world-unique functionalist architecture of Zlin city, where OBZOR comes from. Therefore RETRO line finds its place not only in rustic, vintage, but also in modern loft, minimalist and industrial interiors.



A few clever interior complements, such as switches and outlets, will add to your interior's charm. Our RETRO switch is not just an unobtrusive device that fulfils its essential purpose but is equivalent design companion to the rest of household equipment.



Let us introduce you switches that are everything but discreet. No lines, edges or restraint in dimensions. RETRO switches are round, relatively massive and controlled by a rotary handle.

RETRO switches excel in modern lofts and other minimalist interiors. They will fit well on revealed brick walls, concrete walls as well as on ceramic tiles. RETRO will embellish also rustic interior, e.g. in rural chalets.



DO YOU WANT TO  
KNOW MORE?  
[www.retrovypinac.cz/en](http://www.retrovypinac.cz/en)



RETRO line offers usual range of fittings according to present-day requirements for comfortable living:

- various switching fittings
- shutter controller
- classic outlet (schuko version available)
- computer outlet
- TV outlet
- SAT outlet
- HDMI outlet
- USB charging outlet

There are four collections of noble natural materials to choose from:

- concrete
- glass
- ceramics
- solid wood



TRY OUR  
ONLINE DESIGNER!  
[www.domovnivypinace.cz/en](http://www.domovnivypinace.cz/en)





## concrete collection

Letting concrete into your home needs some courage. Material that may seem maybe a bit too boring and raw at first glance. But due to great technology, high-quality material and great shape you can be rewarded with this brilliant interior solution element.



concrete frame / cover white  
/ single toggle black



concrete frame / cover black  
/ BTA handle black



concrete frame  
/ outlet cover black mat

## glass collection

Design that is not ostentatious or complicated, but simply great. Design that brings up the beauty of the material, real glass. Timeless switches from this collection will highlight modern furnished interiors as well as masterpieces of modern architecture.



glass white frame  
/ OBZ handle patina



glass black frame  
/ BTA handle white



glass white frame  
/ outlet cover black mat





## ceramic collection

Here we combine white and black ceramic frames and covers. In case of switches you can choose from three different types of control handles that will bring up fresh and exciting combinations!



ceramic white frame / cover white  
/OBZ handle patina



ceramic black frame / cover white  
/single toggle black



ceramic black frame / cover black  
/BTA handle white

## hand painted collection

Hand painted white ceramic collection offers single frames in four folklore patterns. These can be combined with any of our covers and handles / toggles.



pattern 1 / cover white  
/double toggle white



pattern 2 / cover white  
/ZLN handle patina



pattern 3 / cover white  
/OBZ handle patina





## wood collection

In this collection we present solid wood frames where you can choose between light oak, dark stained oak and maple in combination with white or cover black.



wooden maple frame / cover white / BTA handle patina



wooden light oak frame / cover black / single toggle white



wooden dark stained oak frame / cover white / double toggle black

## frames

### concrete \*



### glass



### wood \*\*

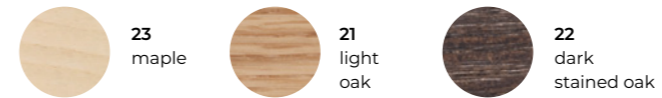

### ceramic

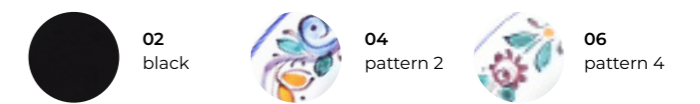

\* Every single frame is unique due to structure of pores.





\*\* For wooden frames we use only solid wood therefore each frame is unique and tone/pattern might slightly vary.



ORDER CODE:

DSR 00-00000-11XX

## frame multiplicities

	DSR 00-00000-11XX	dimensions (h*w) 97*97 mm all collections
	DSR 00-00000-12XX	dimensions (h*w) 97*168 mm ceramic (not painted), concrete, wood, glass
	DSR 00-00000-13XX	dimensions (h*w) 97*239 mm ceramic (not painted), concrete, wood
	DSR 00-00000-14XX	dimensions (h*w) 97*310 mm wood



Fittings and outlets can be combined within up to fourfold frame wall mounted in horizontal or vertical position. Same frame can be used for both options.

## sets



switch arrangement  
1, 2, 5, 6, 7, 1/0,  
shutter switch



switch (glass) arrangement  
1, 2, 5, 6, 7, 1/0,  
shutter switch



single toggle switch  
arrangement 1, 2, 6, 7, 1/0



double toggle switch  
arrangement 5, 6+6,  
shutter switch



LED dimmer



USB outlet  
/ USB charging outlet



HDMI outlet



PC outlet  
Cat. 5E / Cat. 6



TV outlet



SAT outlet



single outlet



schuko  
single outlet



thermostat  
(available only in wooden  
and glass frames)



motion sensor  
(available only in wooden  
and glass frames)



For RETRO series switches, a long-proven cam switch mechanism is used.

## covers



switch cover white  
+ white BTA handle  
DSR 00-01201-0000



switch cover black  
+ white BTA handle  
DSR 00-02201-0000



HDMI, USB, TV, SAT  
outlet cover, white  
DSR 00-91000-0000



switch cover white  
+ black BTA handle  
DSR 00-01202-0000



switch cover black  
+ black BTA handle  
DSR 00-02202-0000



HDMI, USB, TV, SAT  
outlet cover, black  
DSR 00-92000-0000



switch cover white  
+ patina BTA handle  
DSR 00-01203-0000



switch cover black  
+ patina BTA handle  
DSR 00-02203-0000



PC outlet cover,  
white  
DSR 00-93000-0000



switch cover white  
+ patina OBZ handle  
DSR 00-01103-0000



switch cover black  
+ patina OBZ handle  
DSR 00-02103-0000



PC outlet cover,  
black  
DSR 00-94000-0000



switch cover white  
+ patina ZLN handle  
DSR 00-01303-0000



switch cover black  
+ patina ZLN handle  
DSR 00-02303-0000



outlet cover,  
white  
DSR 00-Z1000-0000



cover for a LED dimmer  
rotary button  
DSR 00-03401-0000



cover for a LED dimmer  
rotary button  
DSR 00-03434-0000



outlet cover,  
black mat  
DSR 00-Z2000-0000



cover for a LED dimmer  
rotary button  
DSR 00-04401-0000



cover for a LED dimmer rotary  
button black/black mat  
DSR 00-04434-0000



schuko outlet cover,  
white  
DSR 00-S3000-0000



blind cover  
white  
DSR 60-61000-0000



blind cover  
black  
DSR 60-62000-0000



schuko outlet cover,  
black mat  
DSR 00-S4000-0000



Switch covers and communication outlets cannot be used for RETRO glass collection. You can find covers for RETRO glass on page 23.



Switch covers come with screws supplied in pair in both silver and gold so you can choose which one fits better in your project.

## fittings / outlets



**fitting, arrangement 1**  
singlepole switch  
16 AX, 250 V AC  
**DSR 01-00000-0000**

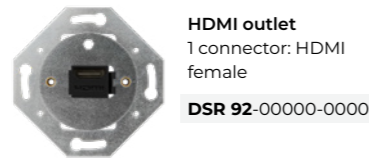

**HDMI outlet**  
1 connector: HDMI female  
**DSR 92-00000-0000**

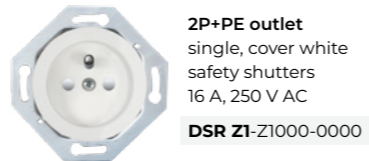

**2P+PE outlet**  
single, cover white safety shutters  
16 A, 250 V AC  
**DSR Z1-Z1000-0000**



**fitting, arrangement 2**  
twopole switch  
16 AX, 250 V AC  
**DSR 02-00000-0000**

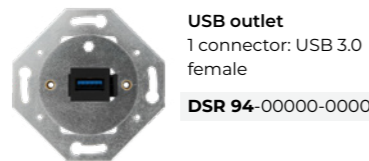

**USB outlet**  
1 connector: USB 3.0 female  
**DSR 94-00000-0000**



**2P+PE outlet**  
single, black mat cover safety shutters  
16 A, 250 V AC  
**DSR Z1-Z2000-0000**



**fitting, arrangement 5**  
serial change-over switch  
16 AX, 250 V AC  
**DSR 05-00000-0000**

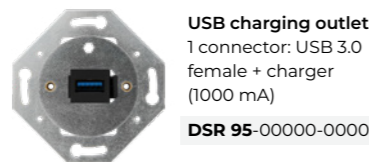

**USB charging outlet**  
1 connector: USB 3.0 female + charger (1000 mA)  
**DSR 95-00000-0000**



**2P+PE schuko outlet**  
single, cover white safety shutters  
16 A, 250 V AC  
**DSR S2-S3000-0000**



**fitting, arrangement 6**  
AC change-over switch  
16 AX, 250 V AC  
**DSR 06-00000-0000**



**TV outlet**  
1 connector: IEC female  
**DSR 97-00000-0000**



**2P+PE schuko outlet**  
single, black mat cover safety shutters  
16 A, 250 V AC  
**DSR S2-S4000-0000**



**fitting, arrangement 7**  
crossbar switch  
16 AX, 250 V AC  
**DSR 07-00000-0000**



**SAT outlet**  
1 connector: female  
**DSR 99-00000-0000**



**blind cover**  
**DSR 60-61000-0000**



**fitting, arrangement 1/0**  
switching controller  
16 AX, 250 V AC  
**DSR 10-00000-0000**



**PC Cat. 5E outlet**  
1 connector: RJ45 Cat. 5E UTP  
**DSR 93-00000-0000**



**blind cover**  
**DSR 60-62000-0000**



**fitting for shutter controller**  
rotary  
16 AX, 230 V AC  
**DSR 22-00000-0000**



**PC Cat. 6 outlet**  
1 connector: RJ45 Cat. 6 UTP  
**DSR 98-00000-0000**



**LED dimmer with arrangement 6**  
230 V AC, load 0-100 W LED, 10-250 W incandescent light bulb  
**DSR 23-00000-0000**

## fittings with covers & toggles



**fitting, arrangement 1**  
single pole switch  
10 AX, 250 V AC  
**DPR 01-01001-0000** cover white / single toggle white  
**DPR 01-01002-0000** cover white / single toggle black  
**DPR 01-01003-0000** cover white / single toggle patina  
**DPR 01-02001-0000** cover black / single toggle white  
**DPR 01-02002-0000** cover black / single toggle black  
**DPR 01-02003-0000** cover black / single toggle patina



**fitting, arrangement 7**  
crossbar switch  
10 AX, 250 V AC  
**DPR 07-01001-0000** cover white / single toggle white  
**DPR 07-01002-0000** cover white / single toggle black  
**DPR 07-01003-0000** cover white / single toggle patina  
**DPR 07-02001-0000** cover black / single toggle white  
**DPR 07-02002-0000** cover black / single toggle black  
**DPR 07-02003-0000** cover black / single toggle patina



**fitting, arrangement 2**  
two pole switch  
10 AX, 250 V AC  
**DPR 02-01001-0000** cover white / single toggle white  
**DPR 02-01002-0000** cover white / single toggle black  
**DPR 02-01003-0000** cover white / single toggle patina  
**DPR 02-02001-0000** cover black / single toggle white  
**DPR 02-02002-0000** cover black / single toggle black  
**DPR 02-02003-0000** cover black / single toggle patina



**fitting, arrangement 1/0**  
switching controller  
10 AX, 250 V AC  
**DPR 10-01001-0000** cover white / single toggle white  
**DPR 10-01002-0000** cover white / single toggle black  
**DPR 10-01003-0000** cover white / single toggle patina  
**DPR 10-02001-0000** cover black / single toggle white  
**DPR 10-02002-0000** cover black / single toggle black  
**DPR 10-02003-0000** cover black / single toggle patina

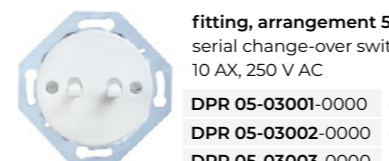

**fitting, arrangement 5**  
serial change-over switch  
10 AX, 250 V AC  
**DPR 05-03001-0000** cover white / double toggle white  
**DPR 05-03002-0000** cover white / double toggle black  
**DPR 05-03003-0000** cover white / double toggle patina  
**DPR 05-04001-0000** cover black / double toggle white  
**DPR 05-04002-0000** cover black / double toggle black  
**DPR 05-04003-0000** cover black / double toggle patina



**fitting for shutter controller**  
10 AX, 250 V AC  
**DPR 16-03001-0000** cover white / double toggle white  
**DPR 16-03002-0000** cover white / double toggle black  
**DPR 16-03003-0000** cover white / double toggle patina  
**DPR 16-04001-0000** cover black / double toggle white  
**DPR 16-04002-0000** cover black / double toggle black  
**DPR 16-04003-0000** cover black / double toggle patina



**fitting, arrangement 6**  
AC change-over switch  
10 AX, 250 V AC  
**DPR 06-01001-0000** cover white / single toggle white  
**DPR 06-01002-0000** cover white / single toggle black  
**DPR 06-01003-0000** cover white / single toggle patina  
**DPR 06-02001-0000** cover black / single toggle white  
**DPR 06-02002-0000** cover black / single toggle black  
**DPR 06-02003-0000** cover black / single toggle patina



**fitting, arrangement 6+6**  
double AC change-over switch  
10 AX, 250 V AC  
**DPR 66-03001-0000** cover white / double toggle white  
**DPR 66-03002-0000** cover white / double toggle black  
**DPR 66-03003-0000** cover white / double toggle patina  
**DPR 66-04001-0000** cover black / double toggle white  
**DPR 66-04002-0000** cover black / double toggle black  
**DPR 66-04003-0000** cover black / double toggle patina

## toggle colors / metal

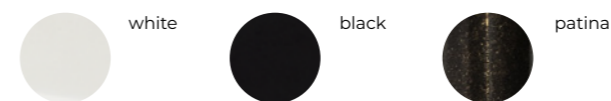

**i** **IMPORTANT:** Recommended min. depth of installation box: for fittings 1, 2, 5, 6 - approx. 42 mm, for USB outlet - approx. 50 mm, for fitting 7, 10, 22 - approx. 60 mm. Optional USB C charger connector socket.

**i** RETRO toggle switches are suitable for installation into standard installation boxes. For more information, see the chapter Technical drawings or contact our sales department. Toggle is always an integral part of the fitting and the cover is supplied with the device. Not for sale separately.

## thermostats and motion sensors



**EBERLE thermostat analogue under plaster mounting ROOM**

- DSR 2T-00000-1130 white glass
- DSR 2T-00000-1131 black glass
- DSR 2T-00000-1121 light oak
- DSR 2T-00000-1122 dark stained oak
- DSR 2T-00000-1123 maple



**EBERLE thermostat analogue under plaster mounting FLOOR with sensor**

- DSR 3T-00000-1130 white glass
- DSR 3T-00000-1131 black glass
- DSR 3T-00000-1121 light oak
- DSR 3T-00000-1122 dark stained oak
- DSR 3T-00000-1123 maple



**EBERLE thermostat digital universal**

- DSR 4T-00000-1130 white glass
- DSR 4T-00000-1131 black glass
- DSR 4T-00000-1121 light oak
- DSR 4T-00000-1122 dark stained oak
- DSR 4T-00000-1123 maple



**B.E.G. motion sensor**

- DSR BX-00000-1130 white glass
- DSR BX-00000-1131 black glass
- DSR BX-00000-1121 light oak
- DSR BX-00000-1122 dark stained oak
- DSR BX-00000-1123 maple



## glass collection



DSR XX-00201-1130 white  
DSR XX-00201-1131 black



DSR XX-00202-1130 white  
DSR XX-00202-1131 black



DSR XX-00103-1130 white



DSR Z1-Z1000-Z130 white  
DSR Z1-Z1000-Z131 black  
DSR Z1-Z2000-Z130 white  
DSR Z1-Z2000-Z131 black



DSR S2-S3000-Z130 white  
DSR S2-S3000-Z131 black  
DSR S2-S4000-Z130 white  
DSR S2-S4000-Z131 black



DSR 92-00000-U130 white  
DSR 92-00000-U131 black



DSR 93-00000-P130 Cat. 5E / white  
DSR 93-00000-P131 Cat. 5E / black  
DSR 98-00000-P130 Cat. 6 / white  
DSR 98-00000-P131 Cat. / black



DSR 94-00000-U130 white  
DSR 94-00000-U131 black



DSR 95-00000-U130 white  
DSR 95-00000-U131 black



DSR 97-00000-U130 white  
DSR 97-00000-U131 black



DSR 99-00000-U130 white  
DSR 99-00000-U131 black



DSR 2T-00000-1130 white  
DSR 2T-00000-1131 black



DSR 3T-00000-1130 white  
DSR 3T-00000-1131 black



DSR 4T-00000-1130 white  
DSR 4T-00000-1131 black



DSR BX-00000-1130 white  
DSR BX-00000-1131 black

**i** For floor connection with our digital thermostat you need to add extra DSR 56 floor sensor.

**i** For more thermostat info go to page 86. Thermostats are available assembled with frames only.

**i** For more motion sensor info go to page 87, X = chosen motion sensor type. Available assembled with frame only.

**i** Glass collection offers white and black frame colours together with BTA white/black and OBZ patina handles.



**i** DSR Z1 / DSR S2 outlets include safety shutters. DSR S1 outlet is without safety shutters.



# decente

*pure lines*

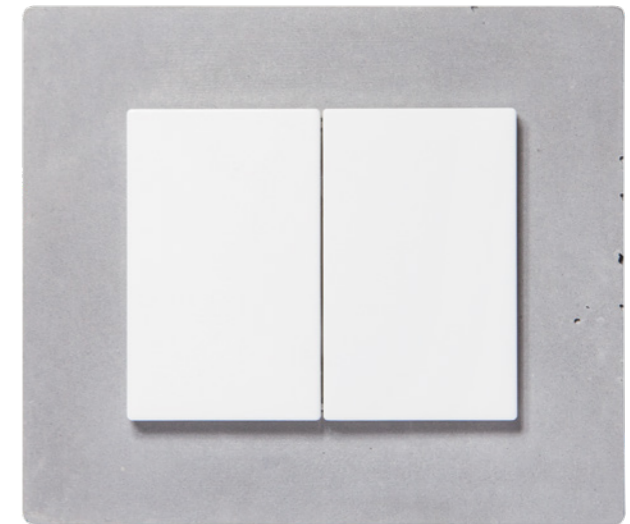

Clean lines, timeless design together with noble natural materials characterize DECENTE series. Wider, luxurious looking glass, wooden, metal, concrete or plexi-glass frames brilliantly accompany various modern interior styles.

Frames of minimal thickness provide an elegant feel. Covers are made of high quality, UV-stable plastic.



## timeless design

Wide selection of beautiful and modern shades of glass, concrete, two kinds of metal, three types of MDF, two plexi and three plexiglass (with glass-effect) colours provide more than enough variations to match up the interior according to your ideas.



wooden walnut MDF frame  
/ cover white



wooden mahogany MDF frame  
/ cover titanium



wooden oak MDF frame  
/ cover white



glass milk white frame  
/ cover white



stainless steel frame  
/ cover black mat

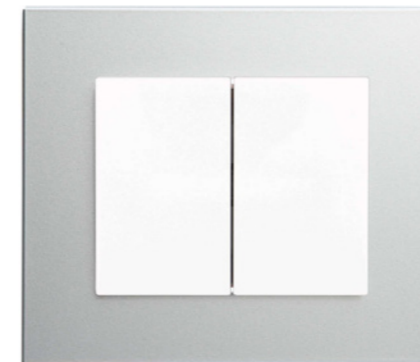







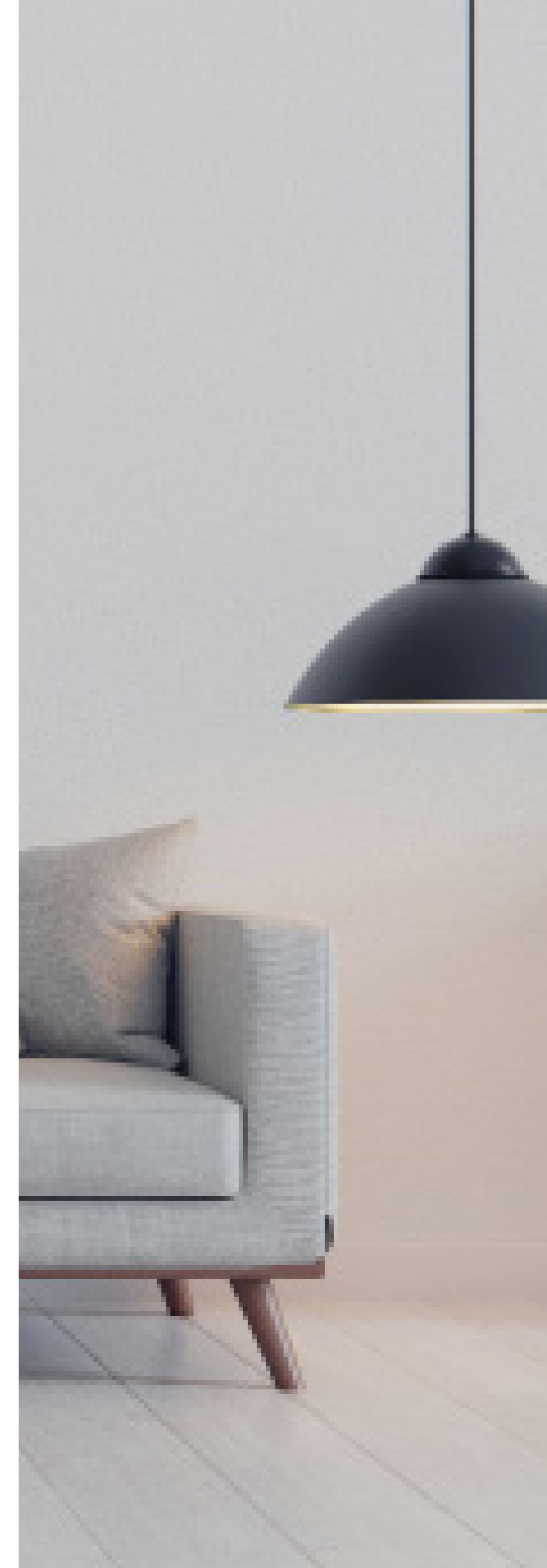

aluminium frame  
/ cover white



plexiglass black frame  
/ cover white



## frame multiplicities

	DSD 00-00000- <b>11XX</b>	dimensions (h×w) 95×110 mm
	DSD 00-00000- <b>12XX</b>	dimensions (h×w) 95×181 mm
	DSD 00-00000- <b>13XX</b>	dimensions (h×w) 95×252 mm
	DSD 00-00000- <b>14XX</b>	dimensions (h×w) 95×323 mm
	DSD 00-00000- <b>21XX</b>	dimensions (h×w) 166×110 mm
	DSD 00-00000- <b>31XX</b>	dimensions (h×w) 237×110 mm
	DSD 00-00000- <b>41XX</b>	dimensions (h×w) 308×110 mm
	DSD 00-00000- <b>82XX</b>	dimensions (h×w) 130×110 mm













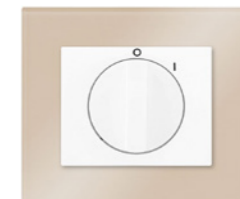















**i** Please note that horizontal and vertical multiple frames have different design.



concrete triple frame / graphite covers

## sets

				
switch arrangement (arrangement 1, 1N, 2, 6, 7, 1/0, 1/0N)	switch arrangement (arrangement 5, 1+1/0, 1/0+1/0, 6+6)	switch with backlighting (arrangement 1S, 2S, 1N, 1/0N, 1/0)	rotary cooker switch three-pole 16 A	rotary shutter controller two-pole (arrangement 1/0+1/0 with locking)
				
shutter controller, rocker switch (arrangement 1/0+1/0, 6/0+6/0 with simultaneous operation electric lock)	rotary dimmer with arr. function 6, also LED rotary dimmer	AUDIO-VIDEO outlet (stereo)	aerial outlet (TV+R+SAT) terminal 1 dB (ZAR-SAT 1,4/K) through 10 dB (ZAR-SAT 10/P3)	aerial outlet (TV+SAT+SAT) through 10 dB (ZAR-SAT 10/P3)
				
single outlet with safety shutters (2P+PE)	single outlet with safety shutters and overvoltage protection (2P+PE) LIGHT INDICATION	single outlet with safety shutters and overvoltage protection (2P+PE) AUDIBLE ALARM	schuko single outlet with safety shutters (2P+PE)	schuko single outlet with safety shutters and overvoltage protection (2P+PE) LIGHT INDICATION
				
double outlet with safety shutters 2x (2P+PE)	double outlet with safety shutters and overvoltage protection 2x (2P+PE) LIGHT INDICATION	single outlet with safety shutters and a IP20 covering lid (2P+PE)	double communication outlet (RJ 45 - 8 Cat. 5E) (RJ 45 - 8 Cat. 6) (RJ 45 Cat. 6 shielded) (RJ 45 Cat. 6A shielded)	double telephone outlet (TZ-1A/2A) with loop checking (TZU-1A/2A)
				
OREG/EBERLE 2T/3T analog thermostat ROOM/FLOOR under-plaster	EBERLE DSD 4T digital thermostat UNIVERSAL (application as floor and corn-bined, it is necessary to buy a sensor) under-plaster	B.E.G. motion sensor	HDMI+PC outlet 2 connectors, HDMI female + PC outlet Cat. 5E / RJ 45-8 for UTP cable	USB+PC outlet 2 connectors, USB 3.0 female + PC outlet Cat. 5E / RJ 45-8 for UTP cable
				
USB outlet with charger + HDMI 2 connectors, USB 3.0 female + HDMI female	2x USB outlet with charger 2 connectors USB 3.0 female			

## frames

### glass (in stock)

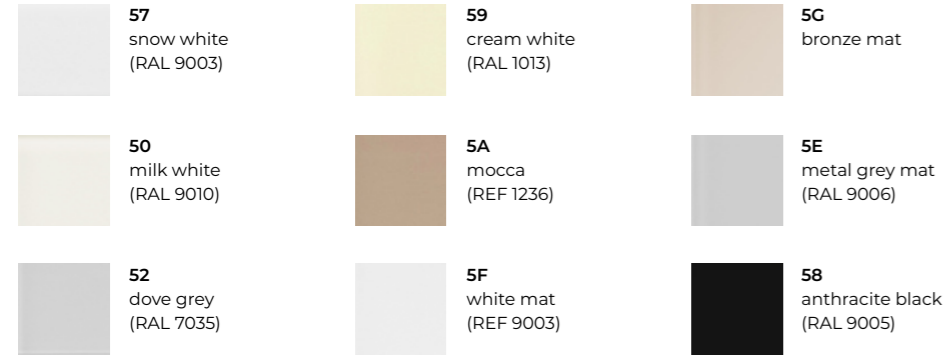

### glass (on request)



### plexi (in stock)

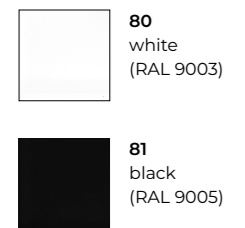

### plexiglass (with glass-effect)

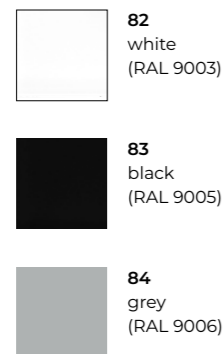

### concrete (on request)



### wood \*(in stock)

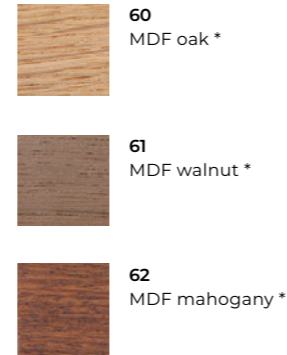

### metal (in stock)

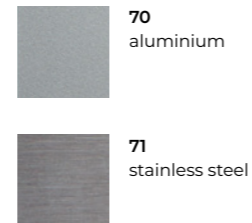

## covers

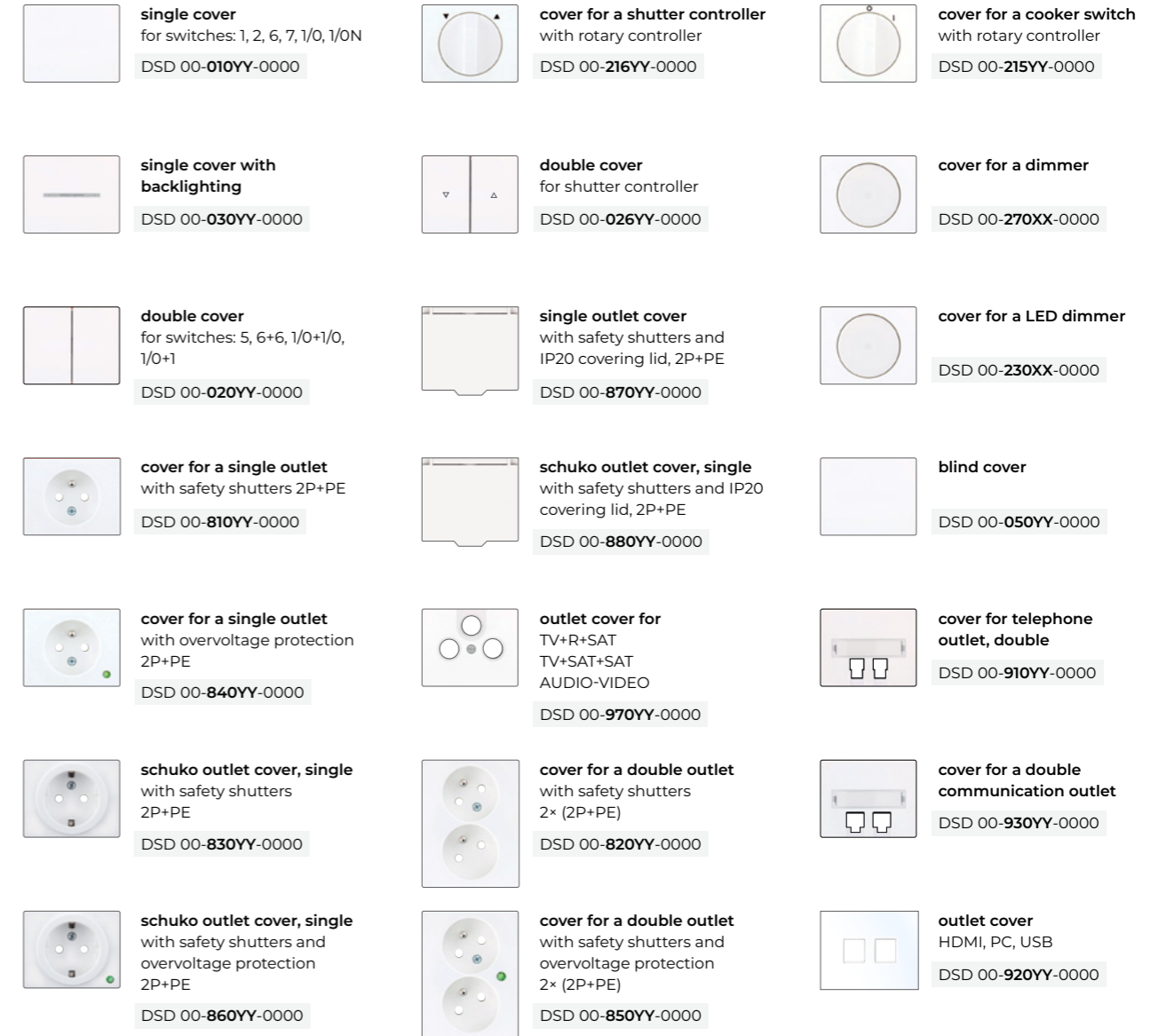

## cover colours

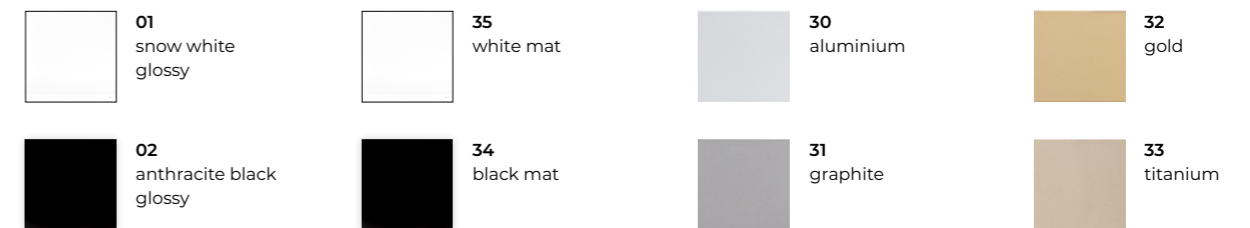

**i** \* Please note that due to uniqueness of natural wooden materials used for DECENTE frames, these may not always be the same, their colour tone and pattern may vary. Colour tones may differ slightly from reality.

**i** ORDER CODE:  
DSD 00-00000-XXXX

**i** ORDER CODE:  
DSD 00-000YY-0000





## fittings

-  **fitting, arrangement 1**  
singlepole switch  
10 AX, 250 V AC  
**DSD 01-00000-0000**
-  **fitting, arrangement 1N**  
singlepole switch with a zero terminal  
10 AX, 250 V AC  
**DSD 12-00000-0000**
-  **fitting, arrangement 2**  
twopole switch  
10 AX, 250 V AC  
**DSD 02-00000-0000**
-  **fitting, arrangement 5**  
serial change-over switch  
10 AX, 250 V AC  
**DSD 05-00000-0000**
-  **fitting, arrangement 6**  
ac change-over switch  
10 AX, 250 V AC  
**DSD 06-00000-0000**
-  **fitting, arrangement 6+6 (6+1)**  
ac change-over switch,  
double 10 AX, 250 V AC  
**DSD 66-00000-0000**
-  **fitting, arrangement 7**  
crossbar switch  
10 AX, 250 V AC  
**DSD 07-00000-0000**
-  **fitting, arrangement 1/0**  
switching controller  
10 AX, 250 V AC  
**DSD 10-00000-0000**
-  **fitting, arrangement 1/0+1/0**  
switching controller, double  
10 AX, 250 V AC  
also suitable as shutter switch without locking  
**DSD 11-00000-0000**
-  **fitting, arrangement 1/0N**  
switching controller with a zero terminal  
10 AX, 250 V AC  
**DSD 13-00000-0000**
-  **fitting, arrangement 1/0+1**  
switching controller  
+ singlepole switch  
10 AX, 250 V AC  
**DSD 14-00000-0000**
-  **fitting, arrangement 6/0+6/0**  
shutter switch with locking  
10 AX, 250 V AC  
**DSD 16-00000-0000**



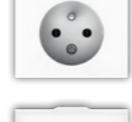





- fitting, arrangement 1+1**  
singlepole switch  
+ singlepole switch  
10 AX, 250 V AC  
**DSD 15-00000-0000**

-  **passive short-press switch**  
switch for intelligent systems  
50 mA, 12 V DC  
**DSD KC-00000-0000**
-  **AUDIO-VIDEO outlet**  
stereo (2+1)  
**DSD 72-00000-0000**
-  **fitting for cooker switch, rotary**  
threepole  
16 A, 400 V AC  
recommended min. depth of installation box - 60 mm  
**DSD 21-00000-0000**
-  **fitting for shutter controller**  
rotary (with locking)  
10 A, 230 V AC  
recommended min. depth of installation box - 60 mm  
**DSD 22-00000-0000**
-  **dimmer fitting with arrangement 6**  
230 V AC, load  
40-250 W  
**DSD 27-00000-0000**
-  **LED dimmer fitting**  
230 V AC, load 0-100 W LED,  
10-250 W incandescent  
light bulb  
**DSD 23-00000-0000**
-  **telephone outlet**  
double  
TZ-1A2A, TZU  
**DSD 91-00000-0000**
-  **communication outlet Cat. 5E / Cat. 6**  
double PC outlet, black connectors  
2x RJ 45-8 for UTP cable  
**DSD 93-00000-0000** Cat. 5  
**DSD 98-00000-0000** Cat. 6
-  **communication outlet Cat. 6 / Cat. 6A**  
double PC outlet, black connectors  
2x RJ 45 shielded for STP cable  
**DSD 74-00000-0000** Cat. 6  
**DSD 75-00000-0000** Cat. 6A
-  **HDMI+PC socket**  
2 connectors: HDMI female  
+ PC outlet Cat. 5E for utp cable  
white connectors  
**DSD 92-00000-0000**
-  **USB+PC socket**  
2 connectors: USB 3.0 female  
+ PC outlet Cat. 5E for utp cable  
white connectors  
**DSD 94-00000-0000**
-  **USB outlet with charger + HDMI**  
2 connectors: USB 3.0 female  
+ HDMI female, white connectors  
(1000 mA)  
**DSD 95-00000-0000**
-  **2x USB outlet with charger**  
2 connectors: USB 3.0 female  
2 connectors, 5 V DC / 1000 mA  
white connectors  
**DSD 96-00000-0000**

-  **outlet TV+R+SAT**  
terminal, attenuation 1 dB, 300 mA, 24 V DC  
for coaxial cables of diameter 4.5-8.3 mm  
type designation on the product: ZAR-SAT 1.4/K  
**DSD 97-00000-0000**
-  **outlet TV+R+SAT**  
through, attenuation 10 dB, 300 mA, 24 V DC  
for coaxial cables of diameter 4.5-8.3 mm  
type designation on the product: ZAR-SAT 10/P3  
**DSD 99-00000-0000**
-  **outlet TV+SAT+SAT**  
through, attenuation 10 dB, 300 mA, 24 V DC  
for coaxial cables of diameter 4.5-8.3 mm  
type designation on the product: ZAR-SAT 10/P3  
**DSD 76-00000-0000**
-  **outlet 2P+PE**  
single socket with safety shutters and IP 20  
covering lid, plastic base 16 A, 250 V AC  
**DSD 89-870YY-0000**
-  **outlet schuko 2P+PE**  
single socket with safety shutters and IP 20  
covering lid, plastic base 16 A, 250 V AC  
**DSD S2-880YY-0000**
-  **2P+PE outlet**  
single, with safety shutters, plastic base  
16 A, 250 V AC  
**DSD 89-810YY-0000**

-  **2P+PE with OP outlet**  
single, with safety shutters and overvoltage  
protection (LIGHT INDICATION)  
16 A, 250 V AC  
**DSD 84-840YY-0000**
-  **2P+PE with OP outlet**  
single, with safety shutters and overvoltage  
protection (AUDIBLE ALARM)  
16 A, 250 V AC  
**DSD 80-810YY-0000**
-  **2P+PE schuko outlet**  
single, with safety shutters  
16 A, 250 V AC  
**DSD S2-830YY-0000**
-  **2P+PE with OP schuko outlet**  
single, with safety shutters and overvoltage  
protection (LIGHT INDICATION)  
16 A, 250 V AC  
**DSD S3-860YY-0000**
-  **2x (2P+PE) outlet**  
double, with safety shutters  
16 A, 250 V AC  
**DSD 82-820YY-0000**
-  **2x (2P+PE) OP outlet**  
double, with safety shutters and with  
overvoltage protection (LIGHT INDICATION)  
16 A, 250 V AC I max 4.5 kA, Up < 1.2 kV  
**DSD 85-850YY-0000**

## outlet cover colours

- |   |   |   |                        |   |                        |   |                       |
|---|---|---|------------------------|---|------------------------|---|-----------------------|
|  | <b>01</b><br>snow white<br>glossy       |  | <b>35</b><br>white mat |  | <b>30</b><br>aluminium |  | <b>32</b><br>gold     |
|  | <b>02</b><br>anthracite black<br>glossy |  | <b>34</b><br>black mat |  | <b>31</b><br>graphite  |  | <b>33</b><br>titanium |

 Power outlets always come in set with a cover of your choice.  
Optional USB charger + USB C charger connector socket.

# decente

audio moduls

*music all around*

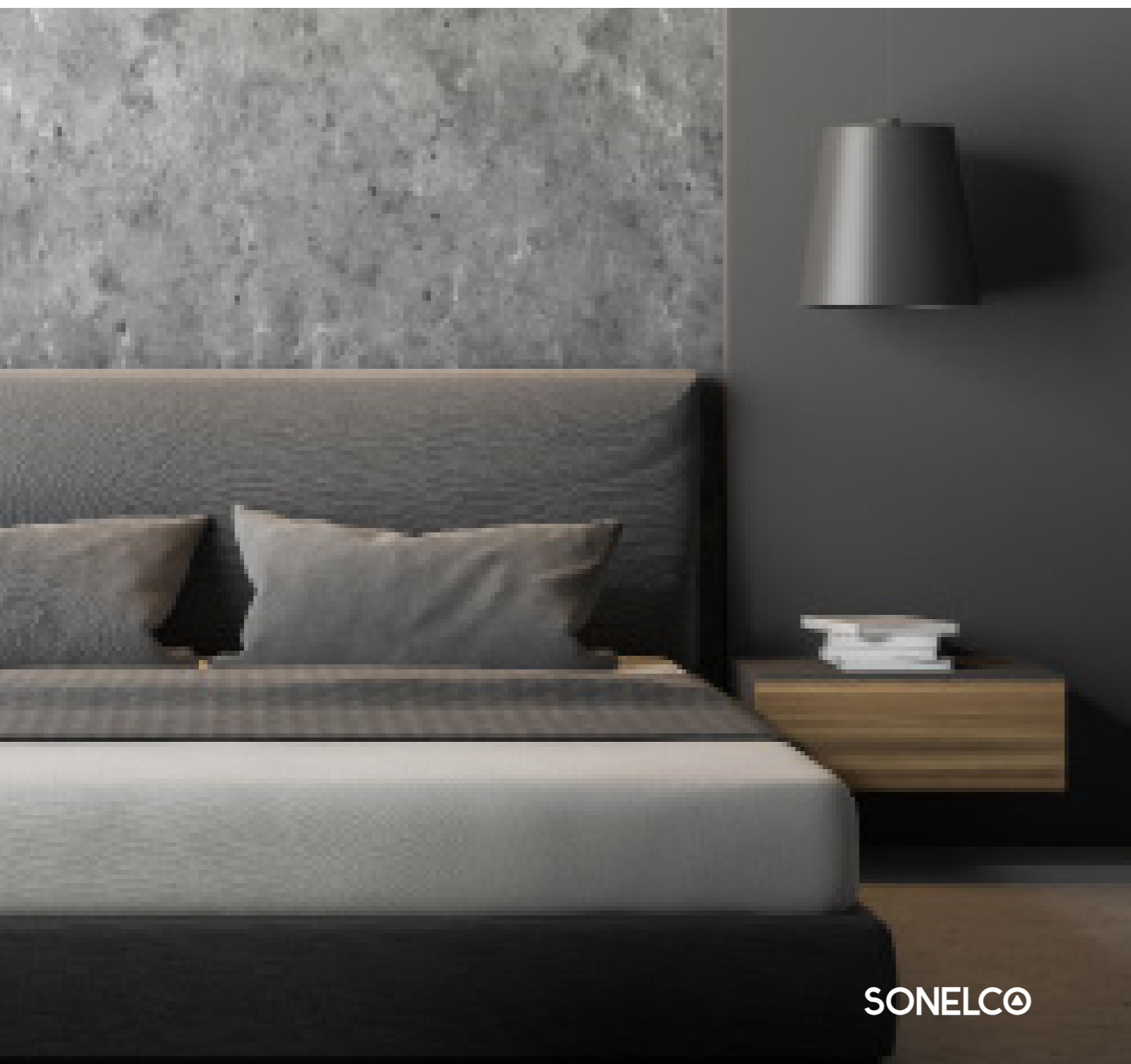

SONELCO products are wall-mounted sound modules that transmit music either wirelessly via Bluetooth, FM radio receiver or AUX input (external device connection). Bluetooth module communicates with phones, tablets or other music devices. This solution is suitable in all households, commercial or healthcare facilities (hotels, restaurants, clinics, spas, etc.).

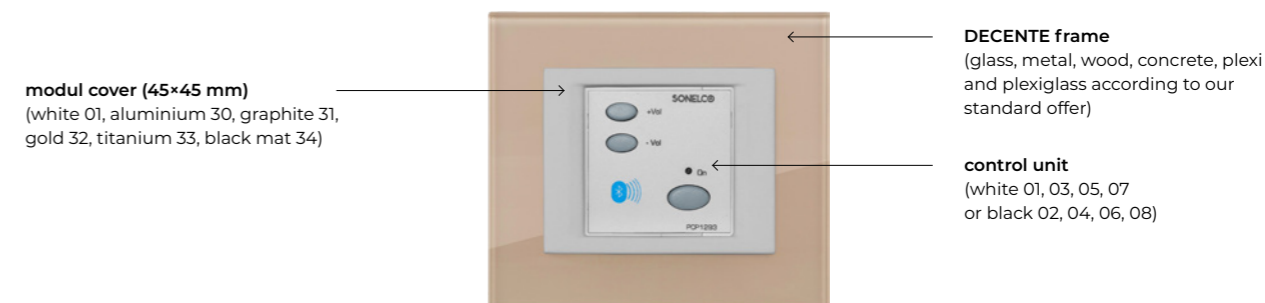

## module types



**control unit FM+Bluetooth**  
needs power supply  
16 V DC, 7.5 W (DSM 90)  
1-channel

**DSM 01 / DSM 02**



**control unit FM+AUX input**  
2-channel  
needs power supply  
16 V DC, 7.5 W (DSM 90)

**DSM 03 / DSM 04**

with built-in power supply 230 V AC

**DSM 05 / DSM 06**



**control unit with bluetooth**  
with built-in power supply  
230 V AC  
1-channel

**DSM 07 / DSM 08**

## accessories



**speaker 4"**  
7 W, 8 Ω, round, white  
**DSM 53**

**speaker 4"**  
25 W, 8 Ω, round, white  
**DSM 54**

**speaker 4"**  
7 W, 8 Ω, IP44, round, white  
**DSM 55**

**speaker 2"**  
2 W, 8 Ω, round, white  
**DSM 52**

**4" speaker cover**  
round, metal, white  
**DSM 00-R2001-0000**  
round, plastic white  
**DSM 00-R1001-0000**

**modul cover**  
45x45 mm  
**DSM 00-M00YY-0000**  
white 01, aluminium 30,  
graphite 31, gold 32,  
titanium 33, black mat 34

**power supply**  
7.5 W, input 230 V AC, output 16 V DC  
needed for DSM 01, 02, 03, 04 units  
**DSM 90**

# decente

hotel systems

*comfortable for guests, simple  
and effective for staff*

ACS-line Reception Hotel System by Estelar Company is designed to secure all activities related to running a hotel or pension. The system includes wall-mounted card readers and energy savers in Decente design available in all standard colours and materials which can match other switches and outlets in Decente design. One hotel card will allow room access, lift control, access to authorized areas (parking, wellness, etc.), payments in hotel bars and restaurants, use of other services (bike rental, ski passes, etc.).



**ESTELAR**  
ELEKTRONICKE SYSTÉMY

## card reader

Card reader (built-in card scanner) is a device for reading cards and controlling individual access according to permission. Typical use is e.g. opening of hotel entrance door, hotel room access, opening of wellness door within allowed time.

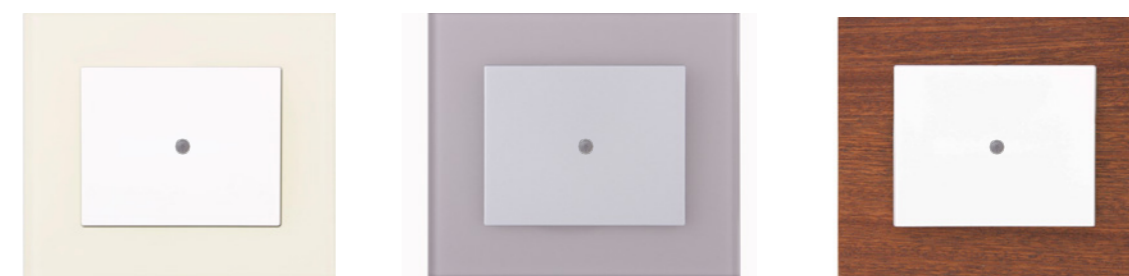

**ORDER CODE:**  
DSD 00-CK0YY-H1XX

## energy saver

Energy Saver is a device that allows to insert a card and thereby invoke an action that lasts while the card is inserted. The device is equipped with a card reader and responds only to authorized cards, so it is not possible to replace the card with for example sturdy paper. Typical use is in a hotel room where the wiring is active only in the presence of a guest or for light control in the meeting room according to its occupancy. Connection of heating sensors for controlling room temperature is also available.



The producer of hotel card readers and hotel systems is ESTELAR, s. r. o.  
More info to be found at [www.acsline.cz](http://www.acsline.cz).



Card readers are offered in DECENTE design with white, black or metallic cover.  
Frame can be chosen from concrete, glass, wood, metal, plexi or plexiglass collection.



**ORDER CODE:**  
DSD 00-HK0YY-H1XX

# decente

smart home solution



## smart home solution

The so-called smart house or home automation provide not only high living comfort, save energy costs, increase safety and entertainment at your fingertips.

Smart home can be controlled by:

- wall mounted short press switches - which you can choose from our timeless DECENTE design
- touch panels
- devices running on iOS or Android systems (computers, smartphones,...)
- TV
- LAN
- sensors and other controllers connected to main central-control unit



### partners



DOMOTRON

more info at  
[controlyourhouse.com](http://controlyourhouse.com)

### compatible smart systems



FIBARO

Shelly





# vectis

by ISD

*minimalist all  
the way*



Let us introduce the all new VECTIS!  
Minimalist shape and colour, made of solid aluminium in mat white or black surface.  
Monolithic panel is brightened up by a subtle lever, a toggle, which refers to historical switches and thanks to rocker-type mechanism is super easy to use.

Vectis series is manufactured by ISD Poland.  
OBZOR is an exclusive distributor for Czech Republic and Slovakia.

## vectis

Toggle switches have been popular back in the past, and now are back - this time in a fresh and modern way! Vectis is not special only because of its design, also the installation has never been easier due to magnetic frames and puzzle shaped metal frames of fittings that simplify the assembly of multiple frames together.



aluminium gold patina / single toggle patina



aluminium brushed aluminium frame / double toggle black



aluminium black frame / double toggle black

## sets



switching arrangement 1, 6, 7, 1/0

switching arrangement 5, 6+6, 1/0+1/0, shutter switch

single outlet

schuko single outlet

HDMI outlet

TV outlet

SAT outlet

PC outlet Cat. 5E / Cat. 6

USB outlet / USB charging outlet

**i** TV+R+SAT socket available in VECTIS series. Custom frames for thermostats on request available.

## frames

### metal - aluminium

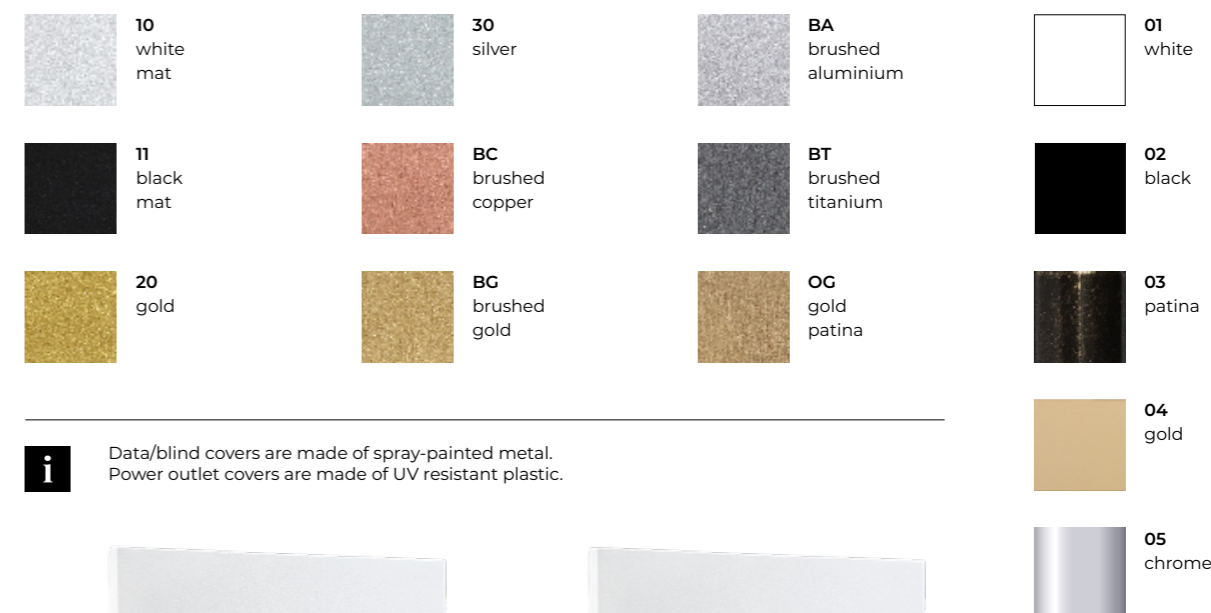

**i** Data/blind covers are made of spray-painted metal. Power outlet covers are made of UV resistant plastic.



## frame multiplicities

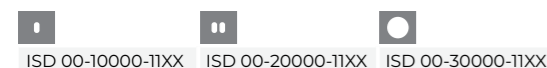

### horizontal

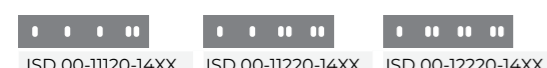

dimensions (h\*w)  
90\*102 mm

dimensions (h\*w)  
90\*173 mm

dimensions (h\*w)  
90\*244 mm

dimensions (h\*w)  
90\*315 mm

### vertical

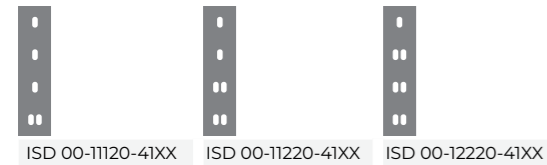
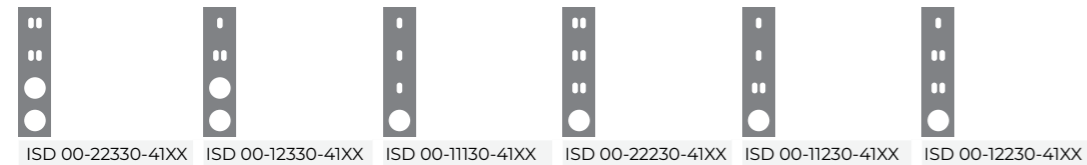
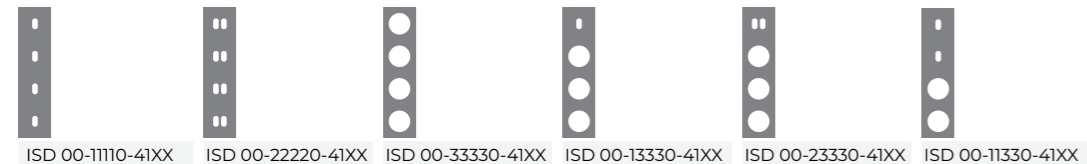
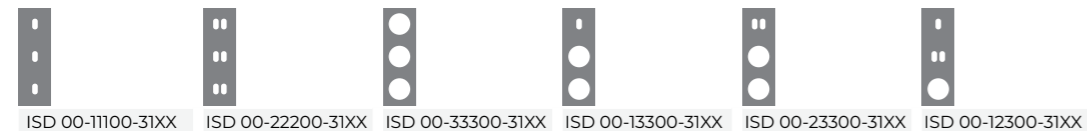

dimensions (h\*w)  
173\*90 mm

dimensions (h\*w)  
244\*90 mm

dimensions (h\*w)  
315\*90 mm

## fittings

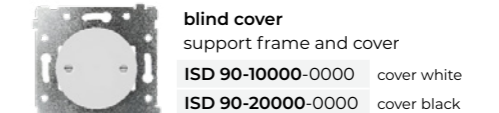
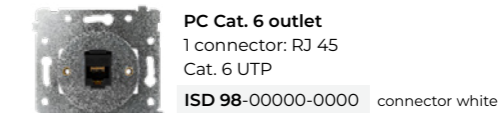
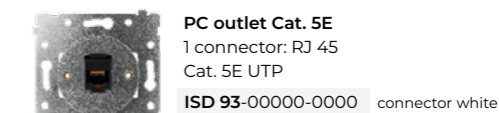
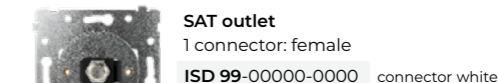
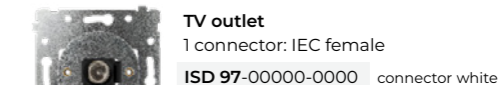
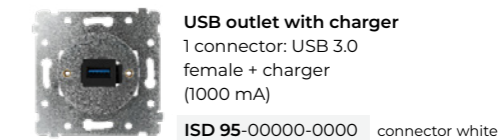
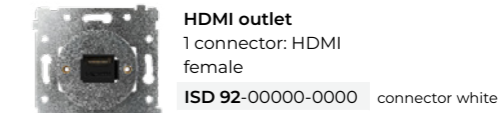
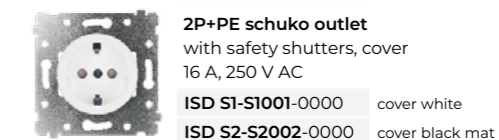
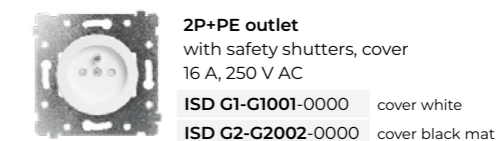
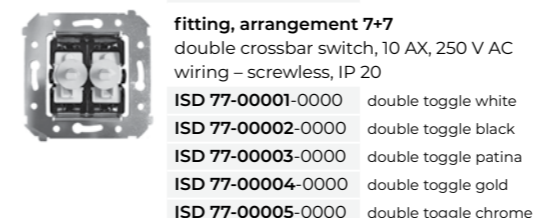
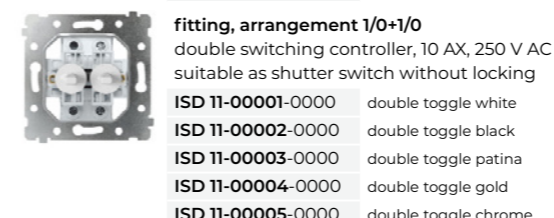
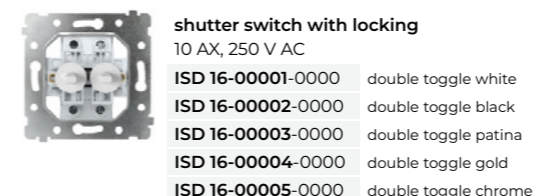
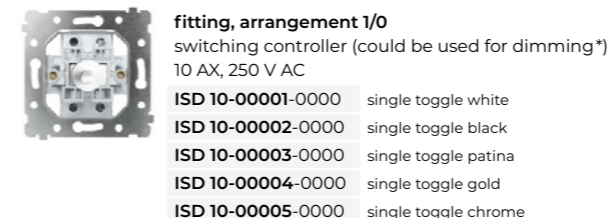
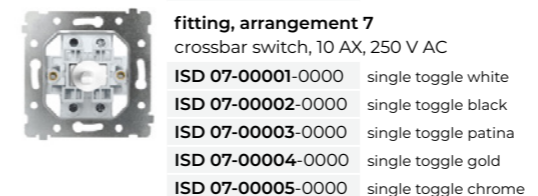
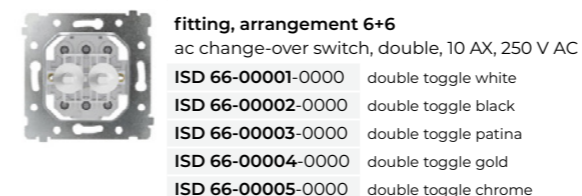
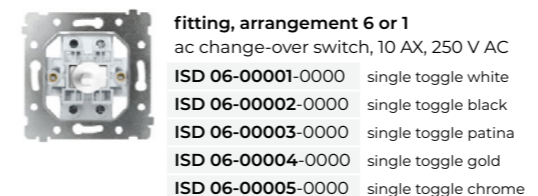
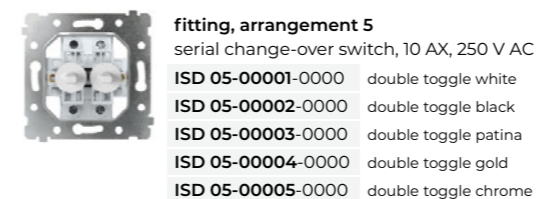

## covers

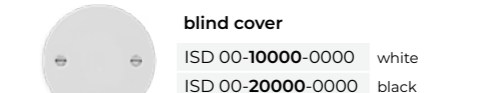
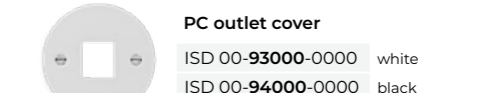
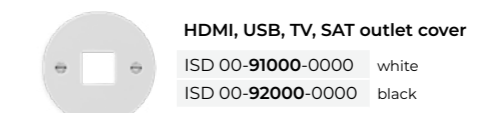

**i** XX = frame colour  
Other combinations of multiple frames can be custom made. For inquiries please get in touch with us / local distributor.  
Custom multiple frames are non-refundable.

**i** \* with a dimming module  
Power outlets always come with cover. Toggles are part of switching mechanisms and cannot be ordered separately.  
Optional USB C charger connector socket.



# vectis round

by ISD

*minimalist all  
the way*



The round frame, the lever mechanism and the attractive way to control the interior lighting – all this is offered by the VECTIS ROUND switches, which with their minimalist design fit into all living styles.

Vectis series is manufactured by ISD Poland.  
OBZOR is an exclusive distributor for Czech Republic and Slovakia.



## vectis round

Round aluminum frames retain their elegance and simplicity. The switches are exceptional not only in their discreet appearance, but also in the way they are mounted. The frames are magnetic, so you just need to put them on the device. Easy operation is ensured by the classic cradle mechanism.



aluminium brushed copper frame  
/ single toggle black



aluminium brushed titanium frame  
/ double toggle white

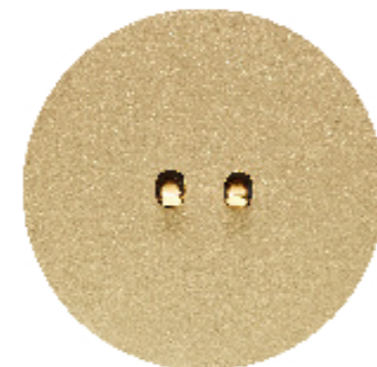

aluminium brushed gold frame  
/ double toggle gold

## sets



switching arrangement  
1, 6, 7, 1/0



switching arrangement  
5, 6+6, 1/0+1/0, shutter switch



single outlet



schuko single outlet



HDMI outlet



TV outlet



SAT outlet



PC outlet Cat. 5E / Cat. 6



USB outlet  
/ USB charging outlet



TV+R+SAT socket available in VECTIS series.  
Custom frames for thermostats on request available.

## frames

### metal - aluminium



10  
white  
mat



30  
silver



BA  
brushed  
aluminium



11  
black  
mat



BC  
brushed  
copper

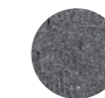

BT  
brushed  
titanium



20  
gold



BG  
brushed  
gold



OG  
gold  
patina



Data/blind covers are made of spray-painted metal.  
Power outlet covers are made of UV resistant plastic.

## toggles

### metal

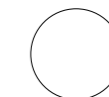

01  
white



02  
black



03  
patina



04  
gold



05  
chrome



## frame multiplicities

ISD R0-10000-11XX  
 ISD R0-20000-11XX  
 ISD R0-30000-11XX

**horizontal**

ISD R0-11000-12XX  
 ISD R0-22000-12XX  
 ISD R0-33000-12XX  
 ISD R0-13000-12XX  
 ISD R0-23000-12XX  
 ISD R0-12000-12XX

ISD R0-11100-13XX  
 ISD R0-22200-13XX  
 ISD R0-33300-13XX  
 ISD R0-13300-13XX  
 ISD R0-23300-13XX  
 ISD R0-12300-13XX

ISD R0-21300-13XX  
 ISD R0-11300-13XX  
 ISD R0-22300-13XX  
 ISD R0-11200-13XX  
 ISD R0-21200-13XX  
 ISD R0-22100-13XX

ISD R0-11110-14XX  
 ISD R0-22220-14XX  
 ISD R0-33330-14XX  
 ISD R0-13330-14XX  
 ISD R0-23330-14XX  
 ISD R0-11330-14XX

ISD R0-22330-14XX  
 ISD R0-12330-14XX  
 ISD R0-21330-14XX  
 ISD R0-11130-14XX  
 ISD R0-22230-14XX  
 ISD R0-11230-14XX  
 ISD R0-12130-14XX

ISD R0-21130-14XX  
 ISD R0-12230-14XX  
 ISD R0-21230-14XX  
 ISD R0-22130-14XX  
 ISD R0-11120-14XX  
 ISD R0-11210-14XX  
 ISD R0-12120-14XX

ISD R0-11220-14XX  
 ISD R0-12210-14XX  
 ISD R0-21210-14XX  
 ISD R0-12220-14XX  
 ISD R0-21220-14XX

**vertical**

ISD R0-11000-21XX  
 ISD R0-22000-21XX  
 ISD R0-33000-21XX  
 ISD R0-13000-21XX  
 ISD R0-23000-21XX  
 ISD R0-12000-21XX

ISD R0-11100-31XX  
 ISD R0-22200-31XX  
 ISD R0-33300-31XX  
 ISD R0-13300-31XX  
 ISD R0-23300-31XX  
 ISD R0-12300-31XX

ISD R0-21300-31XX  
 ISD R0-11300-31XX  
 ISD R0-22300-31XX  
 ISD R0-11200-31XX  
 ISD R0-12100-31XX  
 ISD R0-22100-31XX  
 ISD R0-21200-31XX

ISD R0-11110-41XX  
 ISD R0-22220-41XX  
 ISD R0-33330-41XX  
 ISD R0-13330-41XX  
 ISD R0-23330-41XX  
 ISD R0-11330-41XX

ISD R0-22330-41XX  
 ISD R0-12330-41XX  
 ISD R0-21330-41XX  
 ISD R0-11130-41XX  
 ISD R0-22230-41XX  
 ISD R0-11230-41XX  
 ISD R0-12130-31XX

ISD R0-21130-41XX  
 ISD R0-12230-41XX  
 ISD R0-21230-41XX  
 ISD R0-22130-31XX  
 ISD R0-11120-31XX  
 ISD R0-11210-31XX  
 ISD R0-11220-31XX

ISD R0-11220-31XX  
 ISD R0-12210-31XX  
 ISD R0-21210-31XX  
 ISD R0-12220-31XX  
 ISD R0-21220-31XX

dimensions (h\*w) 97\*97 mm  
 dimensions (h\*w) 97\*168 mm  
 dimensions (h\*w) 97\*239 mm  
 dimensions (h\*w) 97\*310 mm  
 dimensions (h\*w) 168\*97 mm  
 dimensions (h\*w) 239\*97 mm  
 dimensions (h\*w) 310\*97 mm

**i** XX = frame colour  
 Other combinations of multiple frames can be custom made. For inquiries please get in touch with us / local distributor.  
 Custom multiple frames are non-refundable.

## fittings

**fitting, arrangement 5**  
 serial change-over switch, 10 AX, 250 V AC

ISD 05-00001-0000 double toggle white  
 ISD 05-00002-0000 double toggle black  
 ISD 05-00003-0000 double toggle patina  
 ISD 05-00004-0000 double toggle gold  
 ISD 05-00005-0000 double toggle chrome

**fitting, arrangement 6 or 1**  
 ac change-over switch, 10 AX, 250 V AC

ISD 06-00001-0000 single toggle white  
 ISD 06-00002-0000 single toggle black  
 ISD 06-00003-0000 single toggle patina  
 ISD 06-00004-0000 single toggle gold  
 ISD 06-00005-0000 single toggle chrome

**fitting, arrangement 6+6**  
 ac change-over switch, double, 10 AX, 250 V AC

ISD 66-00001-0000 double toggle white  
 ISD 66-00002-0000 double toggle black  
 ISD 66-00003-0000 double toggle patina  
 ISD 66-00004-0000 double toggle gold  
 ISD 66-00005-0000 double toggle chrome

**fitting, arrangement 7**  
 crossbar switch, 10 AX, 250 V AC

ISD 07-00001-0000 single toggle white  
 ISD 07-00002-0000 single toggle black  
 ISD 07-00003-0000 single toggle patina  
 ISD 07-00004-0000 single toggle gold  
 ISD 07-00005-0000 single toggle chrome

**fitting, arrangement 1/0**  
 switching controller (could be used for dimming\*)  
 10 AX, 250 V AC

ISD 10-00001-0000 single toggle white  
 ISD 10-00002-0000 single toggle black  
 ISD 10-00003-0000 single toggle patina  
 ISD 10-00004-0000 single toggle gold  
 ISD 10-00005-0000 single toggle chrome

**shutter switch with locking**  
 10 AX, 250 V AC

ISD 16-00001-0000 double toggle white  
 ISD 16-00002-0000 double toggle black  
 ISD 16-00003-0000 double toggle patina  
 ISD 16-00004-0000 double toggle gold  
 ISD 16-00005-0000 double toggle chrome

**fitting, arrangement 1/0+1/0**  
 double switching controller, 10 AX, 250 V AC  
 suitable as shutter switch without locking

ISD 11-00001-0000 double toggle white  
 ISD 11-00002-0000 double toggle black  
 ISD 11-00003-0000 double toggle patina  
 ISD 11-00004-0000 double toggle gold  
 ISD 11-00005-0000 double toggle chrome

**fitting, arrangement 7+7**  
 double crossbar switch, 10 AX, 250 V AC  
 wiring – screwless, IP 20

ISD 77-00001-0000 double toggle white  
 ISD 77-00002-0000 double toggle black  
 ISD 77-00003-0000 double toggle patina  
 ISD 77-00004-0000 double toggle gold  
 ISD 77-00005-0000 double toggle chrome

**2P+PE outlet**  
 with safety shutters, cover  
 16 A, 250 V AC

ISD G1-G1001-0000 cover white  
 ISD G2-G2002-0000 cover black mat

**2P+PE schuko outlet**  
 with safety shutters, cover  
 16 A, 250 V AC

ISD S1-S1001-0000 cover white  
 ISD S2-S2002-0000 cover black mat

**HDMI outlet**  
 1 connector: HDMI female

ISD 92-00000-0000 connector white

**USB outlet with charger**  
 1 connector: USB 3.0 female + charger (1000 mA)

ISD 95-00000-0000 connector white

**TV outlet**  
 1 connector: IEC female

ISD 97-00000-0000 connector white

**SAT outlet**  
 1 connector: female

ISD 99-00000-0000 connector white

**PC outlet Cat. 5E**  
 1 connector: RJ 45 Cat. 5E UTP

ISD 93-00000-0000 connector white

**PC Cat. 6 outlet**  
 1 connector: RJ 45 Cat. 6 UTP

ISD 98-00000-0000 connector white

**blind cover**  
 support frame and cover

ISD 90-10000-0000 cover white  
 ISD 90-20000-0000 cover black

**covers**

**HDMI, USB, TV, SAT outlet cover**

ISD 00-91000-0000 white  
 ISD 00-92000-0000 black

**PC outlet cover**

ISD 00-93000-0000 white  
 ISD 00-94000-0000 black

**blind cover**

ISD 00-10000-0000 white  
 ISD 00-20000-0000 black

**i** \* with a dimming module  
 Power outlets always come with cover. Toggles are part of switching mechanisms and cannot be ordered separately. Optional USB C charger connector socket.



# elegant

---

*conventional shape,  
rounded lines*



A classic, unobtrusively elegant design with rounded lines and tens of colours to choose from will create a harmonious relationship with any type of interior. Both frame and cover are made of high quality plastic. Soft pastel tones will gently bring up the atmosphere of your interior while rich and colourful on the contrary will play the role of strong accent and attract attention to detail – the switch itself. We also offer our best-selling metallic colours: aluminium, graphite, gold and titanium.

## custom switches

Our unique design allows you to combine any two colours within the frame. Your switch can then look maybe like

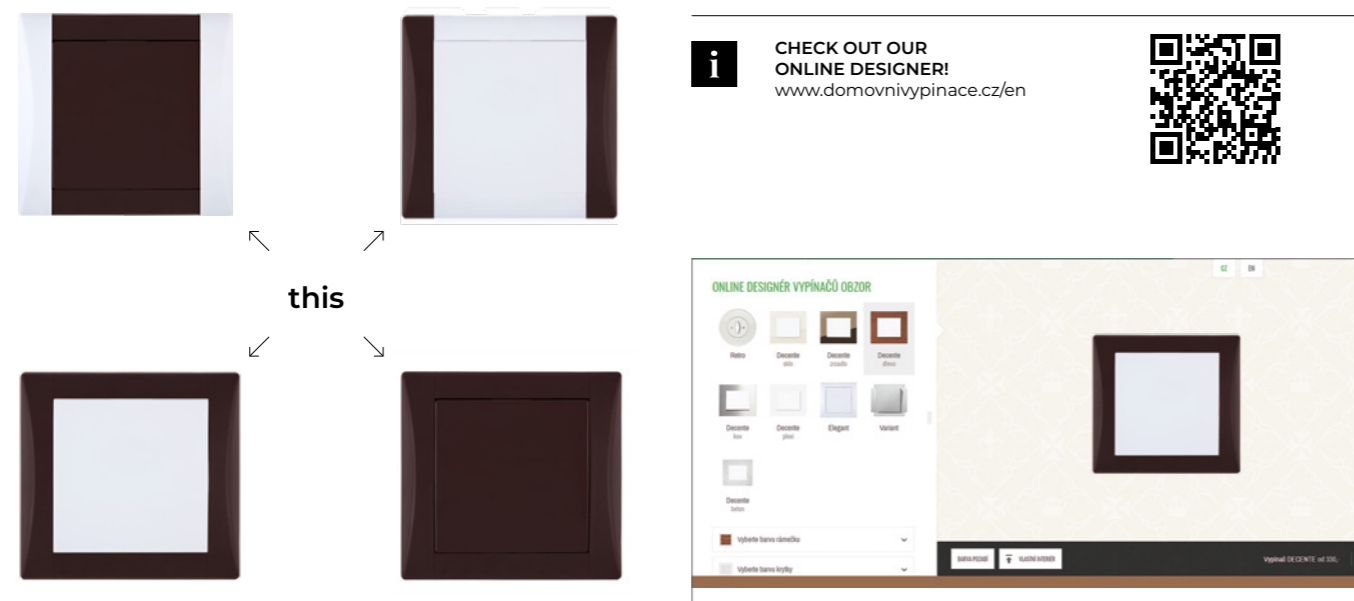

**i** Frames can be combined with covers of any colour. Unique frame design also allows a combination of base and side segments using any combination of two colours. We are always happy to advise you on the selection.

## complex wiring solution in elegant design

The unusual design of the frame connection makes possible to create: up to seven horizontal or triple vertical combinations modul combinations up to 2x5 positions.

### the product line includes

- switches, outlets, controllers
- ELEGANT Aqua (IP 44)
- ELEGANT Medical
- vacuum outlets
- thermostats
- motion sensors

## for your cosy interior

Do you fancy a modern, but also cosy interior where you could use curtains, carpets and other decorations you have personal feelings for? Gentle tones of grey, beige and brown switches would fit right in. These colours do not grow old and will leave you space for further creativity when equipping your interior with other accessories.



cappuccino frame / cover cappuccino



steel grey frame / cover steel grey



titanium frame / titanium grey



## sets

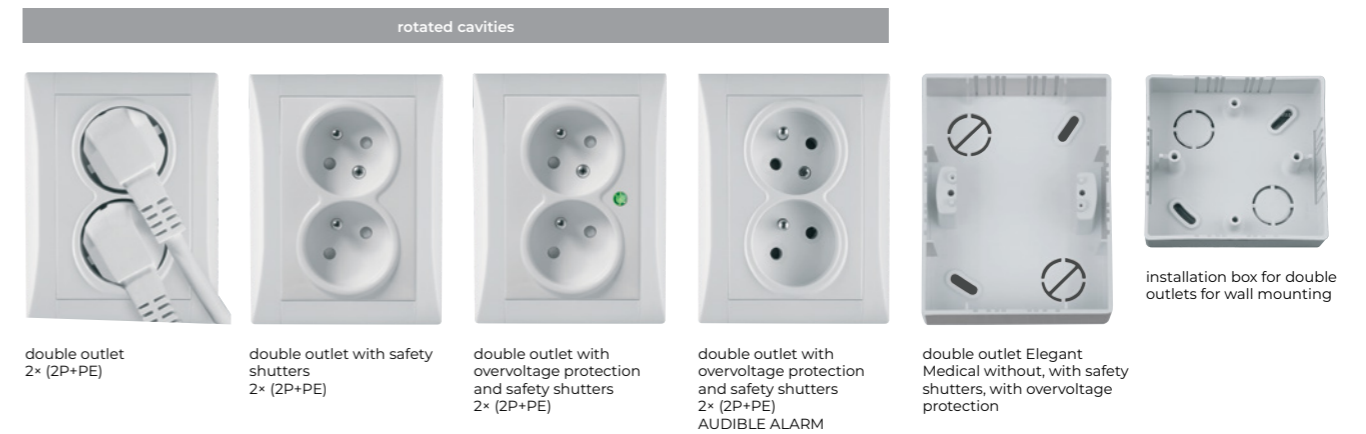
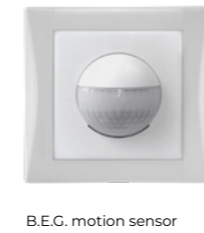
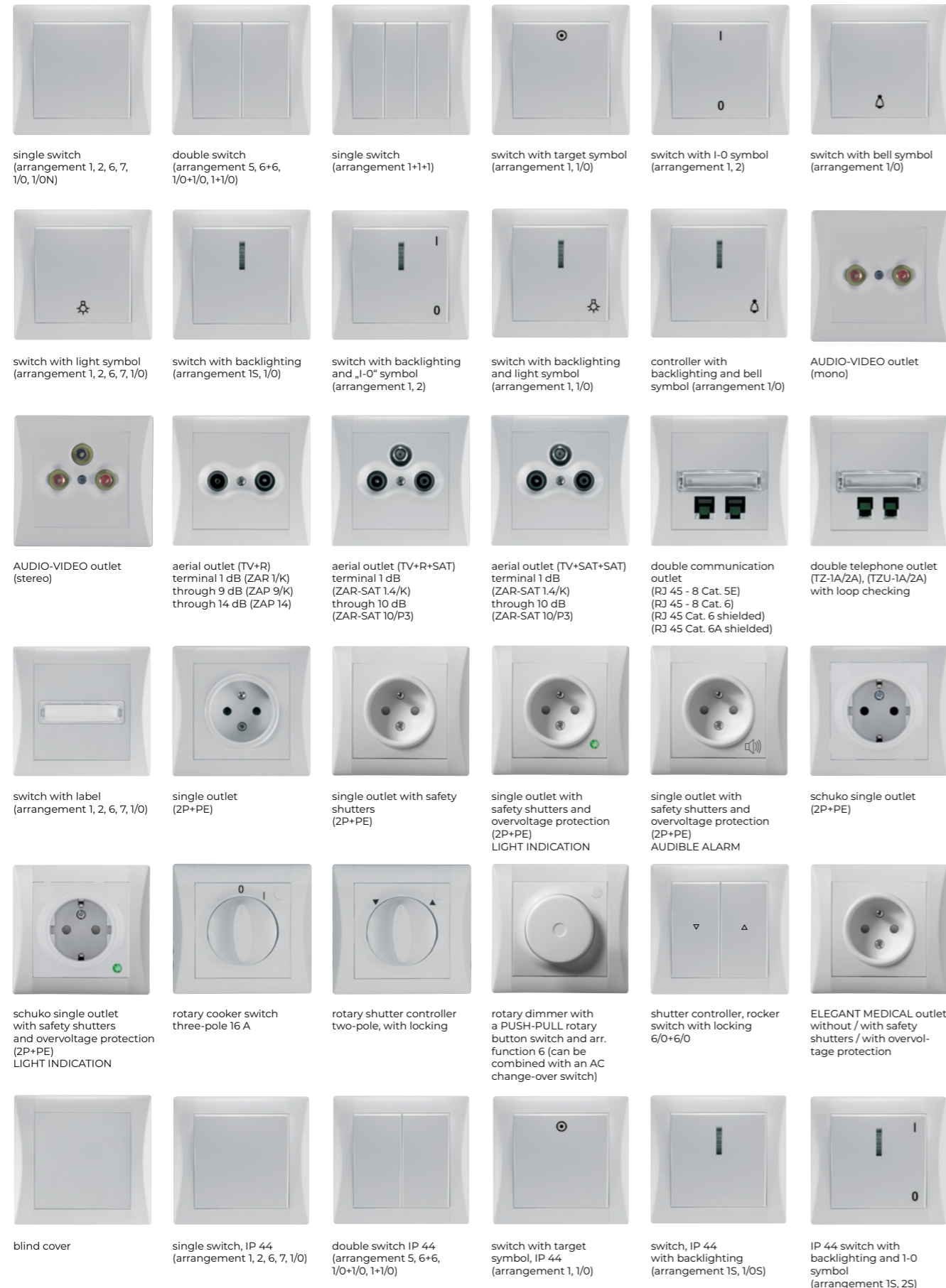

**i** Slightly rotated outlet cavities allow comfortable plugging in of two devices.

















## frames

 <b>01</b> snow white	 <b>06</b> peach orange	 <b>18</b> cappuccino	 <b>30</b> aluminium
 <b>02</b> anthracite black	 <b>08</b> ice green	 <b>19</b> steel grey	 <b>31</b> graphite
 <b>03</b> smoke grey	 <b>09</b> sunflower yellow	 <b>20</b> olive grey	 <b>32</b> gold
 <b>04</b> vanilla yellow	 <b>10</b> signal brown	 <b>21</b> nut brown	 <b>33</b> titanium
 <b>05</b> sandy beige	 <b>11</b> ruby red		

**i** Colour tones may differ slightly from reality.  
Single switch (arrangement 1+1) is only available in white snow, anthracite black, aluminium, graphite, gold and titanium.

## frame multiplicities

 DSE 00-00000-11XXXX	dimensions (h*w) 84*89 mm	 DSE 00-00000-21XXXX	dimensions (h*w) 155*89 mm
 DSE 00-00000-82XXXX	double outlet frame dimensions (h*w) 115*89 mm	 DSE 00-00000-31XXXX	dimensions (h*w) 226*89 mm
 DSE 00-00000-12XXXX	dimensions (h*w) 84*160 mm	 DSE 00-00000-22XXXX	dimensions (h*w) 155*160 mm
 DSE 00-00000-13XXXX	dimensions (h*w) 84*231 mm	 DSE 00-00000-23XXXX	dimensions (h*w) 155*231 mm
 DSE 00-00000-14XXXX	dimensions (h*w) 84*302 mm	 DSE 00-00000-24XXXX	dimensions (h*w) 155*302 mm
 DSE 00-00000-15XXXX	dimensions (h*w) 84*373 mm	 DSE 00-00000-25XXXX	dimensions (h*w) 155*373 mm
 DSE 00-00000-16XXXX	dimensions (h*w) 84*444 mm		
 DSE 00-00000-17XXXX	dimensions (h*w) 84*515 mm		

**i** Please note that horizontal and vertical multiple frames have different design.

**i** ORDER CODE:  
DSE 00-00000-XXXXXX

## covers

-  **single cover**  
for switches:  
1, 2, 6, 7, 1/0, 1/0N, 1N  
DSE 00-010YY-000000
-  **single cover with backlighting with 0-1 symbol**  
for switches fitted with glow-lamp: 1, 1N, 2, 1/0, 1/0N  
DSE 00-031YY-000000
-  **double cover**  
for switches:  
5, 6+6, 1/0+1/0, 1/0+1  
DSE 00-020YY-000000
-  **single cover with 0-1 symbol with a labeling field**  
for switches:  
1, 2, 6, 7, 1/0  
DSE 00-011YY-000000
-  **single cover with a labeling field**  
DSE 00-040YY-000000
-  **triple cover**  
for switches: 1+1+1  
DSE 00-V30YY-000000
-  **single cover with target symbol**  
for switches: 1, 1/0  
DSE 00-012YY-000000
-  **cover for a single outlet with safety shutters 2P+PE**  
DSE 00-890YY-000000
-  **cover for shutter controller with rotary controller**  
DSE 00-216YY-000000
-  **single cover with the bell symbol**  
for switches: 1/0  
DSE 00-013YY-000000
-  **cover for a single outlet with overvoltage protection 2P+PE**  
DSE 00-840YY-000000
-  **cover for cooker switch with rotary controller**  
DSE 00-215YY-000000
-  **cover for a dimmer / cover for LED dimmer**  
DSE 00-270YY-000000  
DSE 00-230YY-000000
-  **schuko outlet cover 2P+PE**  
DSE 00-830YY-000000
-  **double cover for shutter controller**  
DSE 00-026YY-000000
-  **blind cover**  
DSE 00-050YY-000000
-  **schuko outlet cover with overvoltage protection 2P+PE**  
DSE 00-860YY-000000
-  **outlet cover double 2x (2P+PE)**  
DSE 00-820YY-000000
-  **cover for a telephone outlet, double**  
DSE 00-910YY-000000
-  **outlet cover TV+R / AUDIO-VIDEO mono**  
DSE 00-940YY-000000
-  **cover for a double outlet with safety shutters 2x (2P+PE)**  
DSE 00-870YY-000000
-  **cover for a double communication outlet**  
DSE 00-930YY-000000
-  **outlet cover TV+R+SAT (TV+SAT+SAT) AUDIO-VIDEO stereo**  
DSE 00-970YY-000000
-  **cover for a double outlet with overvoltage protection and safety shutters 2x (2P+PE)**  
DSE 00-850YY-000000
-  **single cover with backlighting for switches fitted with glow-lamp: 1, 1N, 2, 1/0, 1/0N**  
DSE 00-030YY-000000
-  **single cover with backlighting with light symbol for switches fitted with glow-lamp: 1, 1N, 2, 1/0, 1/0N**  
DSE 00-034YY-000000
-  **single cover with backlighting with bell symbol for switches fitted with glow-lamp: 1/0, 1/0N**  
DSE 00-033YY-000000







 **ORDER CODE:**  
DSE 00-YYYYY-000000

## cover colours

- |   |   |   |  |
|---|---|---|--|
|  <b>57</b><br>snow white       |  <b>06</b><br>peach orange     |  <b>18</b><br>cappuccino |  <b>30</b><br>aluminium |
|  <b>02</b><br>anthracite black |  <b>08</b><br>ice green        |  <b>19</b><br>steel grey |  <b>31</b><br>graphite  |
|  <b>03</b><br>smoke grey       |  <b>09</b><br>sunflower yellow |  <b>20</b><br>olive grey |  <b>32</b><br>gold      |
|  <b>04</b><br>vanilla yellow   |  <b>10</b><br>signal brown     |  <b>21</b><br>nut brown  |  <b>33</b><br>titanium  |
|  <b>05</b><br>sandy beige      |  <b>11</b><br>ruby red         |   |  |



 Colour tones may differ slightly from reality.  
Single switch (arrangement 1+1+1) is only available in white snow, anthracite black, aluminium, graphite, gold and titanium.







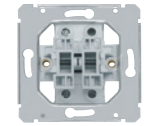
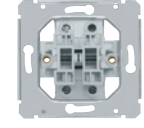
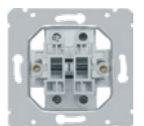



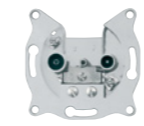
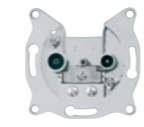
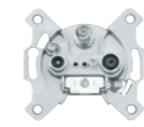
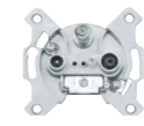
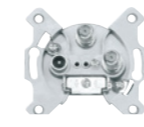
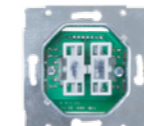







## elegant aqua IP 44 covers

-  **single cover IP 44**  
for switches: 1, 2, 6, 7, 1/0  
DSE 00-510YY-000000
-  **single cover IP 44 with target symbol**  
for switches: 1, 1/0  
DSE 00-512YY-000000
-  **single cover IP 44 with backlighting**  
for switches fitted with a glow-lamp:  
1, 1N, 2, 1/0, 1/0N  
DSE 00-540YY-000000
-  **IP 44 single outlet cover with a lid and safety shutters 2P+PE**  
Available colours only 01, 30, 31, 32, 33.  
The IP44 outlet is always supplied with a transparent (milk white) lid.  
DSE 00-530YY-000000
-  **double cover IP 44**  
for switches: 5, 6+6, 1/0+1/0, 1/0+1  
DSE 00-520YY-000000
-  **IP 44 schuko outlet cover with a lid and safety shutters 2P+PE**  
Available colours only 01, 30, 31, 32, 33.  
The IP44 outlet is always supplied with a transparent (milk white) lid.  
DSE 00-530YY-000000
-  **single cover IP 44 with backlighting and 0-1 symbol**  
for switches fitted with a glow-lamp:  
1, 1N, 2, 1/0, 1/0N  
DSE 00-541YY-000000

 For ELEGANT AQUA cover colours go to page 65.

## fittings

-  **fitting, arrangement 1**  
singlepole switch  
10 AX, 250 V AC  
**DSE 01-00000-000000**
-  **fitting, arrangement**  
in singlepole switch  
with zero terminal  
10 AX, 250 V AC  
**DSE 12-00000-000000**
-  **fitting, arrangement 2**  
twopole switch  
10 AX, 250 V AC  
**DSE 02-00000-000000**
-  **fitting, arrangement 5**  
serial change-over switch  
10 AX, 250 V AC  
**DSE 05-00000-000000**
-  **Fitting, arrangement 6**  
AC change-over switch  
10 AX, 250 V AC  
**DSE 06-00000-000000**
-  **fitting, arrangement 6+6 (6+1)**  
AC change-over switch, double  
10 AX, 250 V AC  
**DSE 66-00000-000000**
-  **fitting, arrangement 7**  
crossbar switch  
10 AX, 250 V A  
**DSE 07-00000-000000**
-  **fitting, arrangement I/O**  
switching controller  
10 AX, 250 V AC  
**DSE 10-00000-000000**
-  **fitting, arrangement 6/0+6/0**  
shutter switch with locking  
10 AX, 250 V AC  
**DSE 16-00000-000000**
-  **fitting, arrangement 1**  
ON switching controller  
with zero terminal  
10 AX, 250 V AC  
**DSE 13-00000-000000**
-  **fitting, arrangement 1/0+1**  
switching controller  
+ singlepole switch  
10 AX, 250 V AC  
**DSE 14-00000-000000**
-  **fitting, arrangement 1+1**  
singlepole switch  
+ singlepole switch  
10 AX, 250 V AC  
**DSE 15-00000-000000**
-  **fitting, arrangement 1/0+1/0**  
double switching controller  
10 AX, 250 V AC  
Ize použit jako žaluziový ovladač bez blokace  
**DSE 11-00000-000000**
-  **fitting, arrangement 1+1+1**  
(3x singlepole switch)  
10AX, 250 V AC  
**DSE V3-00000-000000**
-  **fitting for cooker switch, rotary**  
threepole  
16 A, 400 V AC  
**DSE 21-00000-000000**
-  **fitting for shutter controller, rotary**  
(with locking)  
10 A, 230 V AC  
**DSE 22-00000-000000**
-  **fitting for rotary dimmer**  
with arrangement 6  
230 V AC,  
load 40–250 W  
**DSE 27-00000-000000**
-  **fitting for LED dimmer**  
230 V AC, load  
0–100 W LED, 10–250 W  
incandescent light bulb  
**DSE 23-00000-000000**
-  **telephone outlet double**  
TZ-1A2A  
connectors black  
**DSE 91-00000-000000**
-  **telephone outlet double,**  
with loop checking  
TZU-1A2A  
connectors black  
**DSE 92-00000-000000**
-  **communication outlet Cat. 5E double**  
2x RJ 45 Cat. 5E  
for UTP cable  
connectors black  
**DSE 93-00000-000000**
-  **communication outlet Cat. 6 double**  
2x RJ 45 Cat. 6  
for UTP cable  
connectors black  
**DSE 98-00000-000000**
-  **communication outlet Cat. 6 double**  
2x RJ 45 Cat. 6 shielded  
for STP cable  
connectors black  
**DSE 74-00000-000000**
-  **communication outlet Cat. 6A double**  
2x RJ 45 Cat. 6A shielded  
for STP cable  
connectors black  
**DSE 75-00000-000000**
-  **TV+R outlet terminal**  
attenuation 1 dB, 350 mA, 24 V DC  
for coaxial cables of diameter 4.5–8.3 mm  
designation on the product: ZAR 1/K  
**DSE 94-00000-000000**

-  **TV+R outlet through**  
branching attenuation 9 dB  
for coaxial cables of diameter 4.5–8.3 mm  
designation on the product: ZAP 9/K  
**DSE 95-00000-000000**
-  **TV+R outlet through**  
branching attenuation 14 dB  
for coaxial cables of diameter 4.5–8.3 mm  
designation on the product: ZAP 14  
**DSE 96-00000-000000**
-  **TV+R+SAT outlet**  
terminal, attenuation 1 dB, 300 mA, 24 V DC  
for coaxial cables of diameter 4.5–8.3 mm  
designation on the product: ZAR-SAT 1.4/K  
**DSE 97-00000-000000**
-  **TV+R+SAT outlet**  
through, attenuation 10 dB, 300 mA, 24 V DC  
for coaxial cables of diameter 4.5–8.3 mm  
designation on the product: ZAR-SAT 10/P3  
**DSE 99-00000-000000**
-  **TV+SAT+SAT outlet**  
through, attenuation 10 dB, 300 mA, 24 V DC  
for coaxial cables of diameter 4.5–8.3 mm  
designation on the product: ZAR-SAT 10/P3  
**DSE 76-00000-000000**
-  **passive short-press switch**  
switch for intelligent systems  
50 mA, 12 or 24 V DC  
**DSE KC-00000-000000**
-  **AUDIO-VIDEO outlet**  
mono (1+1)  
**DSE 71-00000-000000**
-  **AUDIO-VIDEO outlet**  
stereo (2+1)  
**DSE 72-00000-000000**
-  **terminal for potential equalization**  
protective bonding outlet 5x terminal  
up to 2.5 mm<sup>2</sup>, 1x terminal up to 6 mm  
**DSE 79-79001-000000**
-  **installation box for wall mounting**  
(ELEGANT only)  
**DSE 31-00000-000000**
-  **installation box for double outlet**  
for wall mounting  
(ELEGANT only)  
**DSE 36-00000-000000**
-  **2x (2P+PE) outlet**  
double  
16 A, 250 V AC  
**DSE 82-820YY-000000**
-  **2P+PE outlet**  
single  
16 A, 250 V AC  
**DSE Z1-890YY-000000**
-  **2P+PE outlet**  
single with safety shutters  
16 A, 250 V AC  
**DSE 89-890YY-000000**
-  **2P+PE with OP outlet**  
single with safety shutters and overvoltage protection,  
(LIGHT INDICATION) 16 A, 250 V AC, I max 4.5 kA,  
Up < 1.2kV  
**DSE 84-840YY-000000**
-  **2P+PE with OP outlet**  
single with safety shutters and overvoltage protection,  
(AUDIBLE ALARM) 16 A, 250 V AC, Up < 1.2 kV  
**DSE 80-890YY-000000**
-  **2P+PE schuko outlet**  
single  
16 A, 250 V AC  
**DSE S1-830YY-000000**
-  **2P+PE schuko outlet**  
single with safety shutters  
16 A, 250 V AC  
**DSE S2-830YY-000000**
-  **2P+PE with OP schuko outlet**  
single with safety shutters and overvoltage protection,  
(LIGHT INDICATION), 16 A, 250 V AC  
**DSE S3-860YY-000000**
-  **2P+PE, IP 44 outlet**  
with lid and safety shutters 16 A, 250 V AC  
**DSE 89-530YY-000000**  
Available colour only 01, 30, 31, 32, 33.  
IP 44 outlet is always supplied with transparent (milk white) lid.
-  **2P+PE schuko outlet**  
with lid and safety shutters 16 A, 250 V AC  
**DSE S2-550YY-000000**  
Available colour only 01, 30, 31, 32, 33.  
IP 44 outlet is always supplied with transparent (milk white) lid.
-  **2x (2P+PE) outlet**  
double with safety shutters (ELEGANT only)  
16 A, 250 V AC  
**DSE 87-870YY-000000**
-  **2x (2P+PE) with OP outlet**  
double with safety shutters and overvoltage  
protection (LIGHT INDICATION)  
16 A, 250 V AC, I max 4.5 kA, Up < 1.2 kV  
**DSE 85-850YY-000000**



# elegant

aqua IP 44

*safety first not only  
in your bathroom*



## IP 44 switches and outlets

ELEGANT AQUA series devices are designed for flush mounting and are supplied with IP 44 protection. These can be used in dusty, damp (bathrooms, warehouses, workshops, garages etc.) or outdoor areas.

XXXX = YY =	2001 - olive grey 01 - white	1901 - steel grey 01 - white	1801 - cappuccino 01 - white	2101 - nut brown 01 - white	1101 - ruby red 01 - white	
XXXX = YY =	0401 - vanilla yellow 01 - white	0901 - sunflower yellow 01 - white	0601 - peach orange 01 - white	1001 - signal brown 01 - white	0101 - snow white 01 - white	
XXXX = YY =	0501 - sandy beige 01 - white	0801 - ice green 01 - white	0301 - smoke grey 01 - white	0201 - anthracite black 01 - white		
XXXX = YY =	3030 - aluminium 01 - white	3131 - graphite 01 - white	3232 - gold 01 - white	3333 - titanium 01 - white	single outlet with transparent lid	
XXXX = YY =	3030 - aluminium 30 - aluminium	3131 - graphite 31 - graphite	3232 - gold 32 - gold	3333 - titanium 33 - titanium	schuko outlet with transparent lid	



Only the colour combinations shown are available for the IP 44 in the ELEGANT range. The IP 44 socket is always supplied with a transparent (milk white) lid.



**ORDER CODE:**  
DSE 00-510YY-51XXXX



IP 44 protection can be used with outlets and switches (arrangements 1, 2, 6, 7, 1/0, 5, 6+6, 1/0+1/0, 1+1/0).

## wall mounted IP 44 switches and outlets

We are an exclusive distributor of MADERA line by Ospel in Czech Republic. MADERA is designed for wall mounting and has IP44 protection, so is suitable for dusty, damp and outdoor areas.

### wall mounted switches and outlets

	<b>LNH-1N/00</b> switch arrangement 1 IP 44, 16 AX - white		<b>LNH-4N/00</b> switch arrangement 7 IP 44, 16 AX - white		<b>LNH-6N/00</b> switch arrangement 1/0 IP 44, 10 AX - white "bell"
	<b>LNH-2N/00</b> switch arrangement 5 IP 44, 16 AX - white		<b>LNH-11N/00</b> switch arrangement 2 IP 44, 16 AX - white "0-1"		<b>LNH-7N/00</b> shutter switch IP 44, 10 AX - white
	<b>LNH-3N/00</b> switch arrangement 6 IP 44, 16 AX - white		<b>LNH-5N/00</b> switch arrangement 1/0 IP 44, 10 AX - white "light"		
	<b>LNH-1NS/00</b> switch arrangement 1 IP 44, 16 AX - white with orange backlight		<b>LNH-4NS/00</b> switch arrangement 7 IP 44, 16 AX - white with orange backlight		<b>LNH-6NS/00</b> switch arrangement 1/0 IP 44, 10 AX - white "bell" with orange backlight and description field
	<b>LNH-2NS/00</b> switch arrangement 5 IP 44, 16 AX - white with orange backlight		<b>LNH-11NS/00</b> switch arrangement 2 IP 44, 16 AX - white "0-1" with orange backlight		<b>LNH-7NS/00</b> shutter switch IP 44, 10 AX - white with orange backlight
	<b>LNH-3NS/00</b> switch arrangement 6 IP 44, 16 AX - white with orange backlight		<b>LNH-5NS/00</b> switch arrangement 1/0 IP 44, 10 AX - white "light" with orange backlight		

### wall mounted outlets

	<b>GNH-1NZ/00/d</b> single outlet IP 44, 16 A - transparent lid
	<b>GNH-1NZP/00/d</b> single outlet IP 44, 16 A - transparent lid and safety shutters
	<b>GNH-2NZ/00/d</b> 2 single outlet IP 44, 16 A - transparent lid
	<b>GNH-2NZP/00/d</b> 2 single outlet IP 44, 16 A - transparent lid and safety shutters
	<b>GNH-3NZ/00/d</b> 3 single outlet IP 44, 16 A - transparent lid
	<b>GNH-3NZP/00/d</b> 3 single outlet IP 44, 16 A - transparent lid and safety shutters

### sample sets

	<b>ZH-NL1G/00/d</b> arrangement 1 + single outlet, IP 44, 16 A - transparent lid
	<b>ZH-NL1SG/00/d</b> arrangement 1 + single outlet, IP 44, 16 A - transparent lid and orange backlight
	<b>ZH-NL2G/00/d</b> arrangement 5 + single outlet, IP 44, 16 A - transparent lid
	<b>ZH-NL2SG/00/d</b> arrangement 5 + single outlet, IP 44, 16 A - transparent lid and orange backlight

outlets are offered with option of

	dark transparent lid (ZH-NL1G/00/d)		white non-transparent lid (ZH-NL1G/00/w)
---	--	---	---

**i** Switches and outlets have screw terminals to secure solid connection of conductors.

# elegant

vacuum outlets



## vacuum outlets

ELEGANT vacuum outlets are designed to be installed in modern interiors. Colours and shape perfectly match ELEGANT switches and socket outlets. They are compatible with BEAM central vacuuming systems.

XXXX = YY =	2001 - olive grey 01 - white	1901 - steel grey 01 - white	1801 - cappuccino 01 - white	2101 - nut brown 01 - white	1001 - signal brown 01 - white	0201 - anthracite black 01 - white
XXXX = YY =	0401 - vanilla yellow 01 - white	0901 - sunflower yellow 01 - white	0601 - peach orange 01 - white	1101 - ruby red 01 - white	0501 - sandy beige 01 - white	0801 - ice green 01 - white
XXXX = YY =	3001 - aluminium 01 - white	3101 - graphite 01 - white	3201 - gold 01 - white	3301 - titanium 01 - white	0301 - smoke grey 01 - white	0101 - snow white 01 - white
XXXX = YY =	3030 - aluminium 01 - white	3131 - graphite 01 - white	3232 - gold 01 - white	3333 - titanium 01 - white		
XXXX = YY =	3030 - aluminium 30 - aluminium	3131 - graphite 31 - graphite	3232 - gold 32 - gold	3333 - titanium 33 - titanium	assembly plate DSE 26-00000-00000	



ELEGANT vacuum cleaners are only available in the colour combinations shown. The mounting plate is not included, but you can order it separately as an accessory. Vacuum outlets are supplied in set only.



**ORDER CODE:**  
DSE 73-730YY-73XXXX



# elegant

medical



Colour outlets are used to clearly resolve circuits with different types of back-up power supply (distributions for healthcare, data and computer networks, etc.). ELEGANT Medical line can be combined with other ELEGANT switches and outlets for a complex wiring solution within given building.

## colour coding of socket outlets



snow white frame / cover green medical

### green - critical circuit

Green outlet cover plates are used for connecting equipment which must have restored provision of emergency power from the main emergency source (usually a diesel generator with auto-start) within at most 2 minutes of a power failure from the primary source. This emergency source supplies electricity for the entire duration of the interruption of the primary source.



snow white frame / cover yellow medical

### yellow - medical isolated circuit

Yellow outlet cover plates are used exclusively for connecting medical equipment essential for sustaining the life and health of patients. The nature of use of this equipment means that its power cannot be interrupted in the event of a fault within the circuit. A medical isolated power system therefore allows operation to continue even in such situations, while the circuit failure is visually and acoustically signalled. Since a further failure could then lead to interruption of system power, it is vital to repair the failure immediately after finishing the ongoing operation. Medical isolated power system is powered from critical circuits. This means that emergency power from the main back-up source is secured within 2 minutes.



snow white frame / cover orange medical

### orange - highly critical circuit

Orange outlet cover plates are designated for power outlets of highly critical circuits whose power may not be interrupted for more than 15 seconds. This will principally involve a medical isolated power system with an even higher level of provision of emergency electrical power supply, because the primary winding of its protective isolation transformer is fed from the UPS, almost always operated in on-line mode (without interruption of the power supply to connected equipment). As the emergency source will have a limited output and operating time, this type of outlet may only be used to supply medical equipment which supports or substitutes basic life functions, which does not have emergency power provided by other means, and for which the power recovery time of the main emergency source is too long.



snow white frame / cover snow white

### white - less critical circuit

White outlet cover plates are designated for connecting routine equipment and appliances (cookers, refrigerators, coffee machines, cleaning equipment etc.). Medical equipment can be connected to these circuits only in exceptional, emergency situations, when there is no power in the other outlets (green, yellow or orange).



snow white frame / cover signal brown

### brown - less critical circuit

Brown cover plates designate outlets of less critical circuits with their protection increased by residual-current devices. They are designated for medical and non-medical equipment where increased protection against electric shock is appropriate or necessary. A connection to a less critical circuit with a residual-current device is designated by the letter code MF.



snow white frame / cover red medical

### red - less critical circuit

Red cover plates are recommended for outlets designated for connecting computers and their accessories into circuits with their own UPS.

## sets



single elegant medical outlet (2P+PE)



single elegant medical outlet with safety shutters (2P+PE)



single elegant medical outlet with safety shutters and overvoltage protection (2P+PE) LIGHT INDICATION



double elegant medical outlet 2x (2P+PE)



double elegant medical outlet with safety shutters 2x (2P+PE)



double elegant medical outlet with safety shutters and overvoltage protection 2x (2P+PE) LIGHT INDICATION

## covers



single outlet cover 2P+PE

DSE 00-890YY-000000



double outlet cover 2x (2P+PE)

DSE 00-820YY-000000



single outlet cover with overvoltage protection 2P+PE

DSE 00-840YY-000000



double outlet cover with overvoltage protection 2P+PE

DSE 00-850YY-000000

## medical cover colours



14 orange medical



15 yellow medical



16 green medical



17 red medical



10 signal brown



01 snow white



Colour tones may differ slightly from reality.



ORDER CODE:  
DSE 00-YYYYY-000101



# variant

*certainly not  
boring*



The courageous design of VARIANT series suits to modern, simply furnished interiors. Bright colours and playful shapes attract attention and look optimistically. Switches will get along with colourful wallpapers, pop art paintings, original accessories such as beanbags, carpets, lighting, etc. Dominant frame colour is combined with neutral cover tone so that the final impression is distinctive, yet balanced.



## variant line

VARIANT and ELEGANT series use the same covers. This makes it too easy to innovate the look of your switches from the original „Elegant“ version by simply replacing the frames with a completely new surprising design!



dandelion yellow frame  
/ cover white



purple violet frame  
/ cover white



storm blue frame  
/ cover white

## courageous design

The courageous design of VARIANT series suits to modern, simply furnished interiors. Bright colours and playful shapes attract attention and look optimistically. Dominant frame colour is combined with neutral cover tones so that the final impression is distinctive, yet balanced.



cinnamon orange frame  
/ cover titanium



lime green frame  
/ cover aluminium



snow white frame  
/ cover graphite

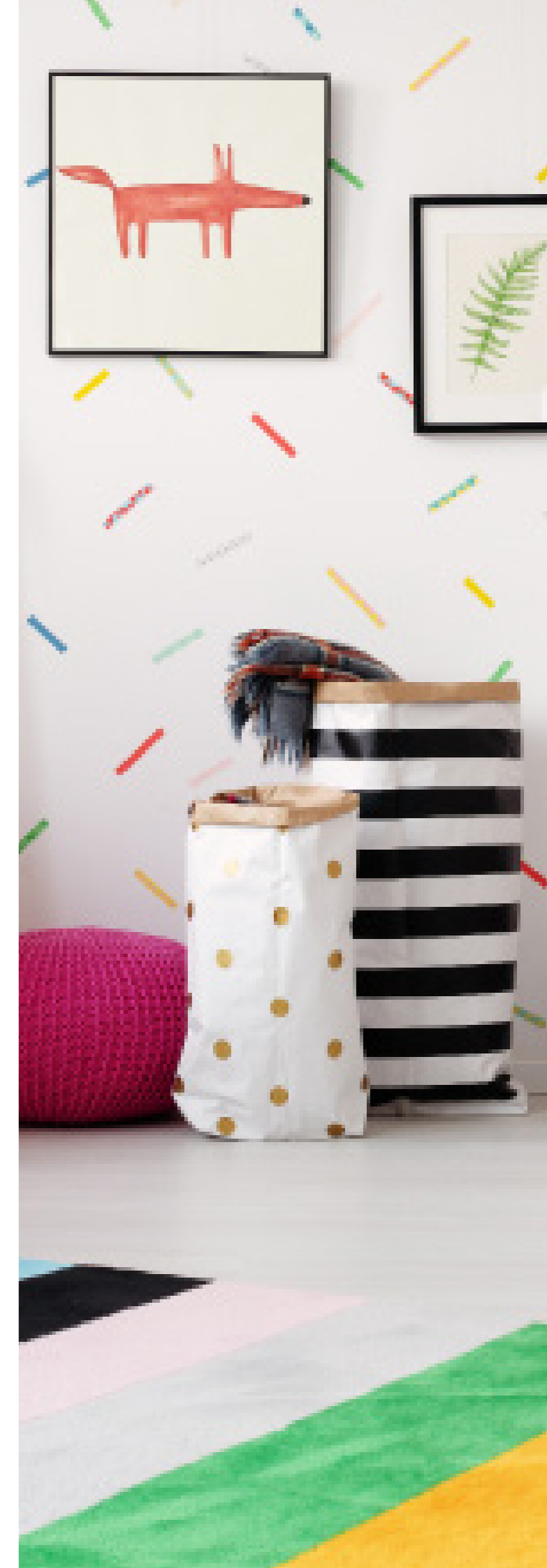

## sets

switch (arrangement 1, 2, 6, 7, 1/0)	double switch (arrangement 5, 6+6, 1/0+1/0, 1+1/0)	switch with target symbol (arrangement 1, 1/0)	switch with 1-0 symbol (arrangement 1, 2)	switch with bell symbol (arrangement 1/0)	switch with light symbol (arrangement 1, 2, 6, 7, 1/0)
switch with backlighting (arrangement 1, 1N, 1/0, 1/0N)	switch with backlighting and 1-0 symbol (arrangement 1, 1N, 2)	switch with backlighting and light symbol (arrangement 1, 1N, 1/0, 1/0N)	switch with backlighting and bell symbol (arrangement 1/0, 1/0N)	AUDIO-VIDEO outlet (mono)	AUDIO-VIDEO outlet (stereo)
aerial outlet (TV+R) terminal 1 dB (ZAR 1/k) through 9 dB (ZAP 9/k) through 14 dB (ZAP 14)	aerial outlet (TV+R+SAT) aerial outlet (TV+SAT+SAT) terminal 1 dB (ZAR-SAT 1.4/k) through 10 dB (ZAR-SAT 10/P3)	double communication outlet (RJ 45 - 8 Cat. 5E) (RJ 45 - 8 Cat. 6) (RJ 45 Cat. 6 shielded) (RJ 45 Cat. 6A shielded)	double telephone outlet (TZ-1A/2A) (TZU-1A/2A) with loop checking	rotary cooker switch threepole 16 A	rotary shutter controller twopole (arrangement 1/0+1/0 with locking)
single outlet (2P+PE)	single outlet with safety shutters (2P+PE)	single outlet with safety shutters and overvoltage protection (2P+PE) LIGHT INDICATION	single outlet with safety shutters and overvoltage protection (2P+PE) AUDIBLE ALARM	single outlet schuko (2P+PE)	single outlet schuko with safety shutters and overvoltage protection (2P+PE) LIGHT INDICATION
rotary dimmer with a push-button switch and arr. function 6 (can be combined with an AC changeover switch)	terminal for potential equalization (protective bonding outlet)	EBERLE 1T analog thermostat ROOM bimetal on-plaster	OREG/EBERLE 2T/3T analog thermostat ROOM/FLOOR under-plaster	EBERLE 4T digital thermostat UNIVERSAL (floor or combined; it is necessary to buy a sensor) under-plaster	STEINEL 1P motion sensor IR 180 UP, wall mounted, under-plaster range 8 m in frame (on request)
blind cover	shutter controller, rocker switch (arrangement 1/0+1/0)	switch with label (arrangement 1, 2, 6, 7, 1/0)			

## frames



### base segment

	<b>51</b> snow white		<b>40</b> coffee white		<b>45</b> nordic blue		<b>46</b> storm blue
	<b>47</b> pistachio green		<b>48</b> lime green		<b>49</b> citrus yellow		<b>50</b> dandelion yellow
	<b>41</b> tropical orange		<b>42</b> cinnamon orange		<b>43</b> purple violet		<b>44</b> cherry red

**i** Colour tones may differ slightly from reality.

**i** ORDER CODE:  
DSE 00-00000-XXXXXX

### side segment

	<b>01</b> snow white		<b>02</b> anthracite black		<b>30</b> aluminium		<b>31</b> graphite
	<b>32</b> gold		<b>33</b> titanium				

**i** ORDER CODE:  
DSE 00-00000-XXXXXX

### frame multiplicities

	DSE 00-00000-11XXXX	dimension (h*w) 82.3*93 mm		DSE 00-00000-13XXXX	dimension (h*w) 82.3*235 mm
	DSE 00-00000-12XXXX	dimension (h*w) 82.3*164 mm			



## fittings

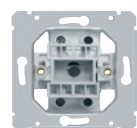

**fitting, arrangement 1**  
singlepole switch  
10 AX, 250 V AC

DSE 01-00000-000000

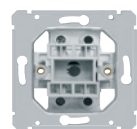

**fitting, arrangement**  
in singlepole switch with  
a zero terminal  
10 AX, 250 V AC

DSE 12-00000-000000

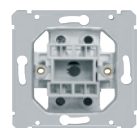

**fitting, arrangement 2**  
twopole switch  
10 AX, 250 V AC

DSE 02-00000-000000

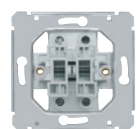

**fitting, arrangement 5**  
serial change-over switch  
10 AX, 250 V AC

DSE 05-00000-000000

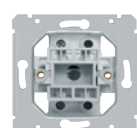

**fitting, arrangement 6**  
ac change-over switch  
10 AX, 250 V AC

DSE 06-00000-000000

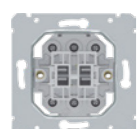

**fitting, arrangement 6+6 (6+1)**  
ac change-over switch,  
double  
10 AX, 250 V AC

DSE 66-00000-000000

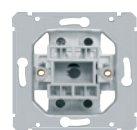

**fitting, arrangement 7**  
crossbar switch  
10 AX, 250 V AC

DSE 07-00000-000000

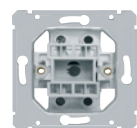

**fitting, arrangement 1/0**  
switching controller  
10 AX, 250 V AC

DSE 10-00000-000000

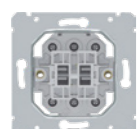

**fitting, arrangement 6/0+6/0**  
shutter switch with locking  
10 AX, 250 V AC

DSE 16-00000-000000

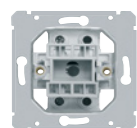

**fitting, arrangement 1/0N**  
switching controller with zero terminal  
10 AX, 250 V AC

DSE 13-00000-000000

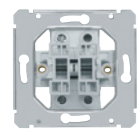

**fitting, arrangement 1/0+1**  
switching controller  
+ singlepole switch  
10 AX, 250 V AC

DSE 14-00000-000000

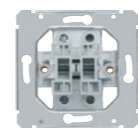

**fitting, arrangement 1+1**  
singlepole switch  
+ singlepole switch  
10 AX, 250 V AC

DSE 15-00000-000000



**fitting for cooker switch, rotary**  
threepole  
16 A, 400 V AC

DSE 21-00000-000000



**fitting for shutter controller, rotary (with locking)**  
10 A, 230 V AC

DSE 22-00000-000000



**dimmer fitting rotary with arr. function 6**  
230 V AC,  
load 40–250 W

DSE 27-00000-000000



**LED dimmer fitting**  
230 V AC, load  
0–100 W LED, 10–250 W  
incandescent light bulb

DSE 23-00000-000000

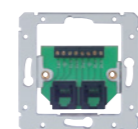

**telephone outlet double**  
TZ-1A2A  
connectors black

DSE 91-00000-000000



**telephone outlet double, with loop checking**  
TZU-1A2A  
connectors black

DSE 92-00000-000000



**communication outlet, Cat. 5E double PC outlet, Cat. 5E**  
2× RJ 45 Cat. 5E, for UTP cable  
connectors black

DSE 93-00000-000000



**communication outlet, Cat. 6 double PC outlet, Cat. 6**  
2× RJ 45 Cat. 6, for utp cable UTP  
connectors black

DSE 98-00000-000000



**communication outlet, Cat. 6 double PC outlet, Cat. 6**  
2× RJ 45 Cat. 6 shielded for STP cable  
connectors black

DSE 74-00000-000000



**communication outlet, Cat. 6A double PC outlet, Cat. 6A**  
2× RJ 45 Cat. 6A shielded for STP cable  
connectors black

DSE 75-00000-000000

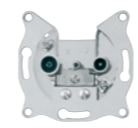

**TV+R outlet**  
terminal, attenuation 1 dB, 350 mA, 24 V DC  
for coaxial cables of diameter 4.5–8.3 mm type  
designation on the product: ZAR 1/K

DSE 94-00000-000000

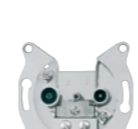

**TV+R outlet**  
through, branching attenuation 9 dB for coaxial  
cables of diameter 4.5–8.3 mm type designation  
on the product: ZAP9/K

DSE 95-00000-000000



**TV+R outlet**  
through, branching attenuation 14 dB  
for coaxial cables of diameter 4.5–8.3 mm  
type designation on the product: ZAP 14

DSE 96-00000-000000

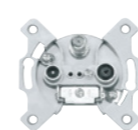

**TV+R+SAT outlet**  
terminal, attenuation 1 dB, 300 mA, 24 V DC  
for coaxial cables of diameter 4.5–8.3 mm type  
designation on the product: ZAR-SAT 1.4/K

DSE 97-00000-000000

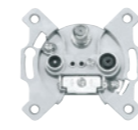

**TV+R+SAT outlet**  
through, attenuation 10 dB, 300 mA, 24 V DC  
for coaxial cables of diameter 4.5–8.3 mm type  
designation on the product: ZAR-SAT 10/P3

DSE 99-00000-000000

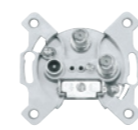

**TV+SAT+SAT outlet**  
through, attenuation 10 dB, 300 mA, 24 V DC  
for coaxial cables of diameter 4.5–8.3 mm type  
designation on the product: ZAR-SAT 10/P3

DSE 76-00000-000000



**passive short-press switch**  
switch for intelligent systems  
12 V DC or 24 V DC

DSE KC-00000-0000



**AUDIO-VIDEO outlet**  
mono (1+1)

DSE 71-00000-000000



**AUDIO-VIDEO OUTLET**  
stereo (2+1)

DSE 72-00000-000000



**terminal for potential equalization**  
protective bonding outlet  
5× terminal up to 2.5 mm<sup>2</sup>, 1× terminal up to 6 mm<sup>2</sup>

DSE 79-79001-000000



**2P+PE outlet**  
single  
16 A, 250 V AC

DSE Z1-890XX-000000



**2P+PE outlet**  
single with safety shutters  
16 A, 250 V AC

DSE 89-890XX-000000



**2P+PE with OP outlet**  
single with safety shutters and overvoltage  
protection (LIGHT INDICATION)  
16 A, 250 V AC

DSE 84-840XX-000000



**2P+PE with OP outlet**  
single, with safety shutters and overvoltage  
protection (AUDIBLE ALARM)  
16 A, 250 V AC

DSE 80-890XX-000000



**2P+PE schuko outlet**  
single  
16 A, 250 V AC

DSE S1-830XX-000000



**2P+PE schuko outlet**  
single with safety shutters  
16 A, 250 V AC

DSE S2-830XX-000000



**2P+PE with OP schuko outlet**  
single, with safety shutters and overvoltage  
protection (LIGHT INDICATION)  
16 A, 250 V AC







DSE S3-860XX-000000

## covers

- |  |   |  |
|--|---|--|
|  <b>single cover</b><br>for switches: 1, 2, 6, 7, 1/0, 1/0N<br>DSE 00-010YY-000000   |  <b>single cover with backlighting with light symbol</b><br>for switches fitted with glow-lamp: 1, 1N, 2, 1/0, 1/0N<br>DSE 00-034YY-000000 |  <b>cover for a double communication outlet, double</b><br>DSE 00-930YY-000000                                     |
|  <b>single cover with 0-1 symbol</b><br>for switches: 1, 2, 6, 7, 1/0<br>DSE 00-011YY-000000   |  <b>double cover</b><br>for switches: 5, 6+6, 1/0+1/0, 1/0+1<br>DSE 00-020YY-000000  |  <b>outlet cover single</b><br>2P+PE<br>DSE 00-890YY-000000  |
|  <b>single cover with target symbol</b><br>for switches: 1, 1/0<br>DSE 00-012YY-000000   |  <b>cover for a cooker switch with a rotary controller</b><br>DSE 00-215YY-000000  |  <b>outlet cover with safety shutters and overvoltage protection</b><br>2P+PE<br>DSE 00-840YY-000000               |
|  <b>single cover with bell symbol</b><br>for switches: 1/0<br>DSE 00-013YY-000000  |  <b>cover for shutter controller with a rotary controller</b><br>DSE 00-216YY-000000   |  <b>schuko outlet cover single</b><br>2P+PE<br>DSE 00-830YY-000000   |
|  <b>single cover with light symbol</b><br>for switches: 1, 2, 6, 7, 1/0<br>DSE 00-014YY-000000   |  <b>cover for a dimmer with a rotary controller</b><br>DSE 00-270YY-000000   |  <b>schuko outlet cover single with safety shutters and overvoltage protection</b><br>2P+PE<br>DSE 00-860YY-000000 |
|  <b>single cover with backlighting</b><br>for switches fitted with glow-lamp: 1, 1N, 2, 1/0, 1/0N<br>DSE 00-030YY-000000                  |  <b>cover for a LED dimmer with a rotary controller</b><br>DSE 00-230YY-000000  |  <b>outlet cover TV+R / AUDIO-VIDEO mono</b><br>DSE 00-940YY-000000   |
|  <b>single cover with backlighting with 0-1 symbol for switches fitted with glow-lamp:</b><br>1, 1N, 2, 1/0, 1/0N<br>DSE 00-031YY-000000 |  <b>blind cover</b><br>DSE 00-050YY-000000   |  <b>outlet cover TV+R+SAT TV+SAT+SAT AUDIO-VIDEO STEREO</b><br>DSE 00-970YY-000000                               |
|  <b>single cover with backlighting with bell symbol for switches fitted with glow-lamp:</b><br>1/0, 1/0N<br>DSE 00-033YY-000000          |  <b>cover for a telephone outlet, double</b><br>DSE 00-910YY-000000  |  <b>single cover with a labeling field</b><br>DSE 00-040YY-000000  |

NOTE:  
Only in white and metallic colours.

## cover colours

- |  |   |  |   |
|--|---|--|---|
|  <b>01</b><br>snow white |  <b>02</b><br>anthracite black |  <b>30</b><br>aluminium |  <b>31</b><br>graphite |
|  <b>32</b><br>gold       |  <b>33</b><br>titanium         |  |   |

 **ORDER CODE:**  
DSE 00-000YY-000000





# thermostats and motion sensors

retro, decente, elegant,  
variant design



Various thermostats and motion sensors can be aligned in the same design as the rest of switches and outlets. Motion sensors automatically switch most often lighting and are useful mainly in the premises with frequent movement of people. Thermostats observe room temperature and optimally regulate heating, some allow you to set different time scenarios. Choose reliable devices from a wide range of materials and colours among our RETRO, DECENTE, ELEGANT or VARIANT products.



**EBERLE**

# thermostats



PRODUCT	THERMOSTAT RTR-E 8011-50	THERMOSTAT FRE L2A-50 LIMITER	THERMOSTAT FIT 3U	THERMOSTAT FIT 3U	THERMOSTAT FIT 3U
order code	DSE 2T, DSD 2T*, DSR 2T	DSE 3T, DSD 3T*, DSR 3T	DSE 4T, DSD 4T*, DSR 4T	DSE 4T, DSD 4T*, DSR 4T	DSE 4T, DSD 4T*, DSR 4T
description	analogue thermostat under plaster mounting ROOM (modular 50x50)	analogue thermostat under plaster mounting FLOOR (modular 50x50) with sensor	digital thermostat under plaster mounting ROOM (modular 50x50)	digital thermostat under plaster mounting FLOOR** (modular 50x50)	digital thermostat under plaster mounting COMBINED (modular 50x50)
dimensions (h×w×d)	84×89×42 mm	84×89×42 mm	84×89×42.5 mm	84×89×42.5 mm	84×89×42.5 mm
temperature range	10–40 °C	10–40 °C	5–30 °C	10–40 °C	10–40 °C room a 10–40 °C floor
contact (relay)	switching (AC 230 V)	switching (AC 230 V)	switching (AC 230 V)	switching (AC 230 V)	switching (AC 230 V)
working voltage	AC 230 V 50 Hz	AC 230 V 50 Hz	AC 230 V 50 / 60 Hz	AC 230 V 50 / 60 Hz	AC 230 V 50 / 60 Hz
switching current	10 (4) A	10 (4) A	10 mA–10 (4) A	10 mA–16 (4) A	10 mA–10 (4) A
hysteresis	cca 1 K	cca 1 K	in steps of 0.1°C	in steps of 0.1°	in steps of 0.1°
regulation	ON/OFF	ON/OFF	PWM or ON/OFF	PWM or ON/OFF	PWM or ON/OFF
protection	IP 30	IP 30	IP 30	IP 30	IP 30

**i** \* If you order an ELEGANT or VARIANT frame, order the device with code DSE XX. If device is used with DECENTE design, proceed with code DSD XX. If device is used with RETRO design, proceed with code DSR XX.  
\*\* Floor sensor is sold separately as DSE 56.



PRODUCT	FLOOR SENSOR
order code	DSE 56
description	floor sensor for EBERLE thermostats
dimensions (h×w×d)	4 m
temperature range	0–70 °C

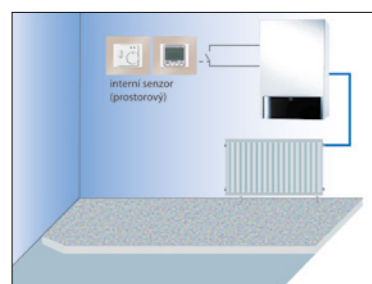

**ROOM THERMOSTATS**  
Allow measurement of room temperature using an intergrated room sensor and regulation (swit-ching) of e.g. central heating boilers (potential-free contact).

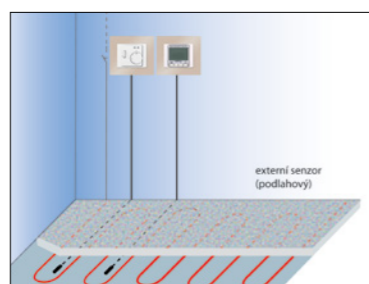

**FLOOR THERMOSTATS**  
Used mainly for controlling the temperature of underfloor heating using an external sensor. Can also be used for sensing and regulation in other media (tubes, liquids, solid and loose materials etc.).

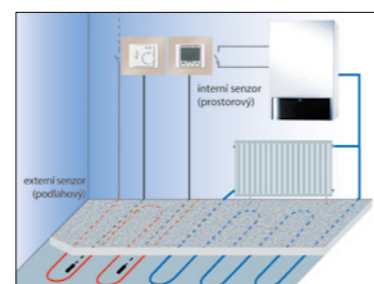

**COMBINED THERMOSTATS**  
Temperature can thus be regulated using an internal or external sensor. Used with e.g. underfloor heating, where room sensor works as the main sensor and floor sensor as protection against overheating.



PRODUCT	PIR SENSOR 180-R	PIR SENSOR 180-T	PIR SENSOR 180-R-2D	PIR SENSOR 180-TR
order code	DSE B1 / DSD B1' / DSR B1 - B1001	DSE B2 / DSD B2' / DSR B2 - B1001	DSE B3 / DSD B3' / DSR B3 - B1001	DSE B4 / DSD B4' / DSR B4 - B1001
description	Wall-mounted motion detector with acoustic sensor. Relay version in three-wire technology. Automatic extension of transition time through sounds. Possible manual button control.	Wall-mounted motion detector with acoustic sensor. Triac design with 2-wire technology, without zero conductor. Only for ohmic loads. Automatic extension of transition time through sounds.	Wall-mounted motion detector with acoustic sensor. Relay design with 2-wire technology thanks to built-in battery. Automatic extension of transition time through sounds.	Wall-mounted motion detector designed for switching staircase automatic lights. Triac design with 2-wire without zero-conductor. It guarantees perfect operation with LUXOMAT® SCT1 (up to 10 detectors per device).
dimensions (h×w×d)	mounting depth 36 mm	mounting depth 36 mm	mounting depth 36 mm	mounting depth 36 mm
power	2 300 W, cos φ = 1 1 150 W, cos φ = 0,5	300 W / min. 40 W cos φ = 1 not suitable for LED	2 300 W cos φ = 1 not suitable for LED	max. 200 mA / 230 V
voltage	110–240 V AC 50 / 60 Hz	110–240 V AC 50 / 60 Hz	110–240 V AC 50 / 60 Hz 5× NiMh / 30 AAAA, 1.2 V / 200 mA	110–240 V AC , 50 / 60 Hz operation via a staircase automat (230 V)
coverage angle	180° vertically	180° vertically	180° vertically	180° vertically
range	max. 10 m	max. 10 m	max. 10 m	max. 10 m
twilight setting	2–2 000 lux	2–2 000 lux	2–2 000 lux	2–2 000 lux
time setting	15 s – 16 min nor bell impulse	15 s – 16 min nor bell impulse	15 s – 16 min nor bell impulse	impulse duration 0.1 s
protection	IP 20 / class II	IP 20 / class II	IP 20 / class II	IP 20 / class II

PRODUCT	PIR SENSOR 180 M 2C	PIR SENSOR 180 S	PIR SENSOR 180-R-11-48V	PIR SENSOR 180-KNX
order code	DSE B5 / DSD B5' / DSR B5 - B1001	DSE B6 / DSD B6' / DSR B6 - B1001	DSE B7 / DSD B7' / DSR B7 - B1001	DSE B8 / DSD B8' / DSR B8 - B1001
description	Wall-mounted presence detector, master model. Switching channel for switching the light on. Potential-free HVAC contact. Possible extension of detection range with slave devices. Automatic extension of transition time through the sounds.	Wall-mounted presence detector, slave model. To extend the detection range of master model. Compatible with all master devices except: PD4-M- DS-FC, 11-48V devices, PD9-M- SDB.	Wall-mounted motion detector with acoustic sensor with operating voltage 11–48 V. Potential-free switching contact. Possible manual button control.	Wall-mounted presence detector KNX with acoustic sensor and integrated BUS connector. When using B.E.G._Occupancy detector_928XX_V5.0, several operating modes are available:
dimensions (h×w×d)	mounting depth 36 mm	mounting depth 36 mm	mounting depth 36 mm	mounting depth 36 mm
power	channel 1 (lighting check): 2 300 W, cos φ = 1 1 150 VA, cos φ = 0,5 channel 2 (HVAC check): 3 A, 230 V, cos φ = 1	slave	3 A cos φ = 1	KNX
voltage	110–240 V AC 50 / 60 Hz	110–240 V AC 50 / 60 Hz	11–48 V AC / DC	KNX
coverage angle	180° vertically	180° vertically	180° vertically	180° vertically
range	max. 10 m	max. 10 m	max. 10 m	max. 10 m
twilight setting	2–2 000 lx	2–2 000 lx	2–2 000 lx	2–2 000 lx
time setting	channel 1: 15 s – 30 min, impuls channel 2: 5 min – 120 min, impuls, alarm impuls	impuls 2 s or 9 s	impuls 15 s – 30 min	
protection	IP 20 / class II	IP 20 / class II	IP 20 / class II	IP 20 / class II

**i** \* Motion sensors can be implemented into ELEGANT, VARIANT (use DSE XX), DECENTE (use DSD XX) or RETRO design (use DSR XX).

## universal accessories



**PC connector Cat. 5E**  
RJ 45 black plastic  
set of 2 pcs  
for UTP cable

**DSE 33-00000-000000**



**PC connector Cat. 6**  
RJ 45 black plastic  
set of 2 pcs  
for UTP cable

**DSE 34-00000-000000**



**PC connector Cat. 6**  
shielded  
RJ 45 Cat. 6  
set of 2 pcs  
for STP cable

**DSE 24-00000-000000**



**PC connector Cat. 6A**  
shielded  
RJ 45 Cat. 6A  
set of 2 pcs  
for STP cable

**DSE 25-00000-000000**



**spacer VK1**  
fills up the gap between installation  
box and fitting

**DSE 29-00000-000000**



**spacer VK2**  
fills up the gap between installation  
box and fitting

**DSE 30-00000-000000**



**connector CINCH  
AUDIO-VIDEO**  
mono  
set of 2 pcs

**DSE 38-00000-000000**



**connector CINCH  
AUDIO-VIDEO**  
stereo  
set of 3 pcs

**DSE 39-00000-000000**



**glow lamp**  
230 V, 2 MA

**DSE 3A-00000-000000** orange

230 V, 0,5 MA

**DSE 3B-00000-000000** green

**DSE 3C-00000-000000** blue



**fixative spurs**  
(claws)  
set of 2 pcs

**DSE 37-00000-000000**



**5103 MDE mounting plate**  
for central vacuum  
cleaner outlets

**DSE 26-00000-000000**



**support frame for PC  
connectors**

**DSE 35-00000-000000**

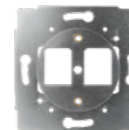

**support frame for  
HDMI and USB connectors**  
for DECENTE line

**DSD 35-00000-0000**



# wiring diagrams

switch arrangement 1 (singlepole switch)

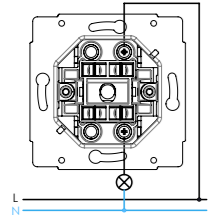

Used to control one device or one device group from one place. For other switches there is only one device in a given switching circuit considered.

switch arrangement 1+1+1

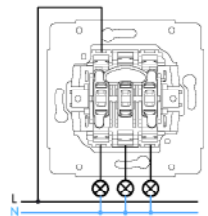

switch arrangement 2 (twopole switch)

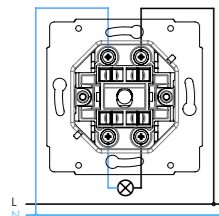

Usually used where it is needed to turn off work and central wire at the same time.

switch arrangement 5 (serial change-over switch, singlepole) two circuit switch with switched-off position)

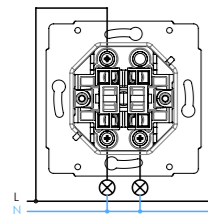

For controlling two electrical circuits from one spot.

single outlet

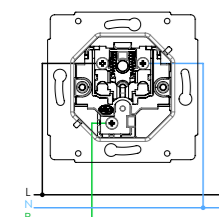

Connects electrical device to electricity grid. Safety outlets are also available: outlet with safety shutters, IP 44 outlet.

double outlet

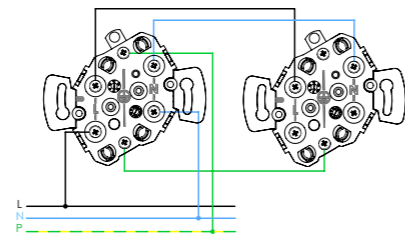

Double outlets connects electrical devices to electricity grid

switch arrangement 6 stair switch (change-over switch), singlepole 2-way switch without switched off position

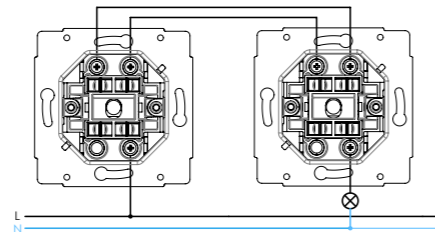

Classic control of staircase or hallway lighting from two spots.

switch arrangement 6+6 double stair switch (serial change-over switch)

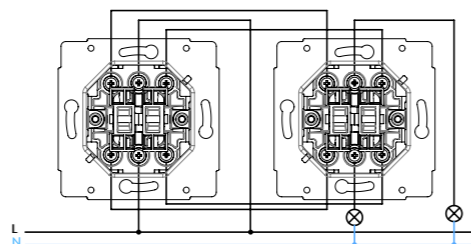

For controlling two electrical circuits from two spots.

switch arrangement 6+7+6 change-over switch - cross-bar switch - change-over switch

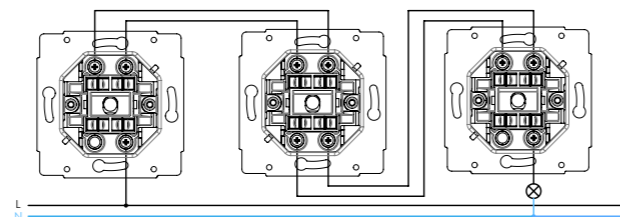

Between two switches 6, any number of switches 7 can be placed.

# wiring diagram for retro (cam switch)

arrangement 1

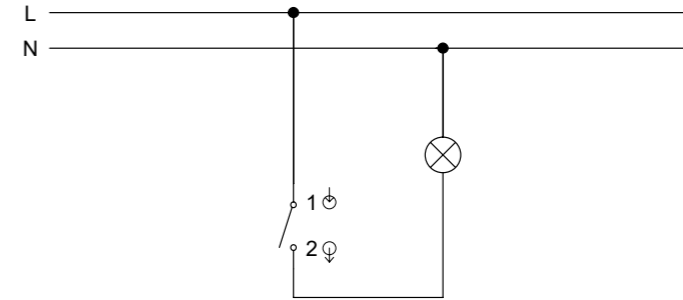

arrangement 2

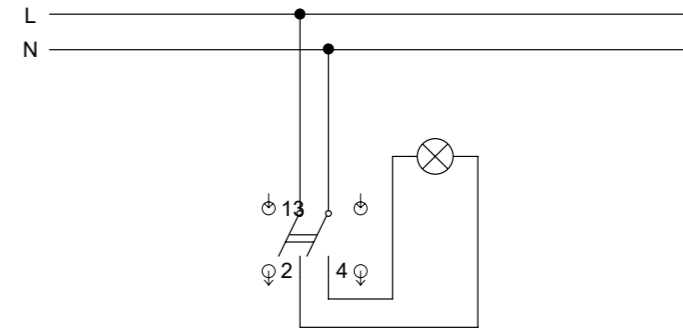

arrangement 5

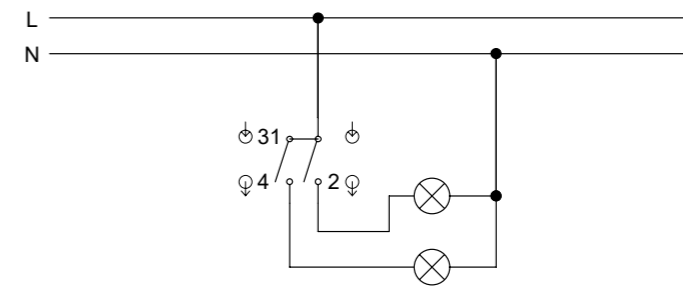

arrangement 6

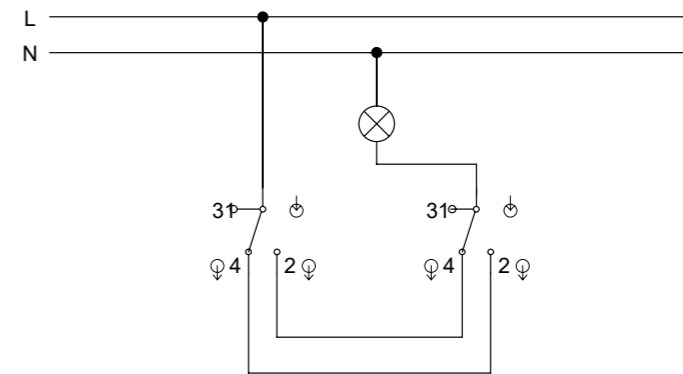

arrangement 6+7+6

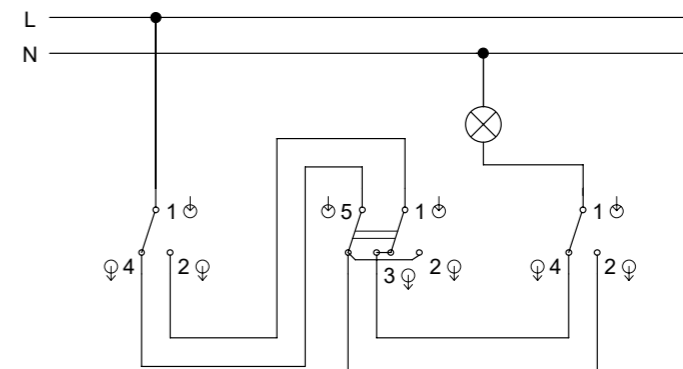

## retro

### frames

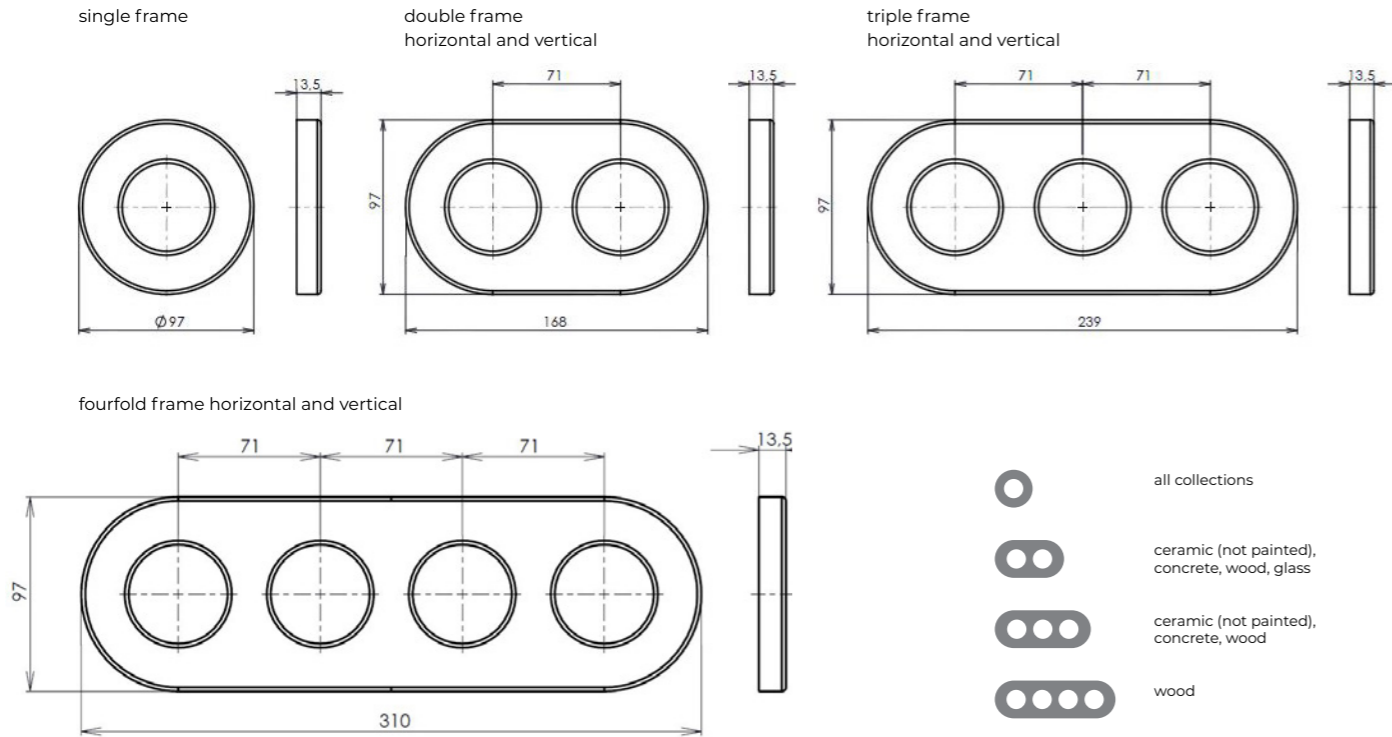

**i** Multiple frames can be installed both horizontally and vertically (are compatible).

### frames for glass collection

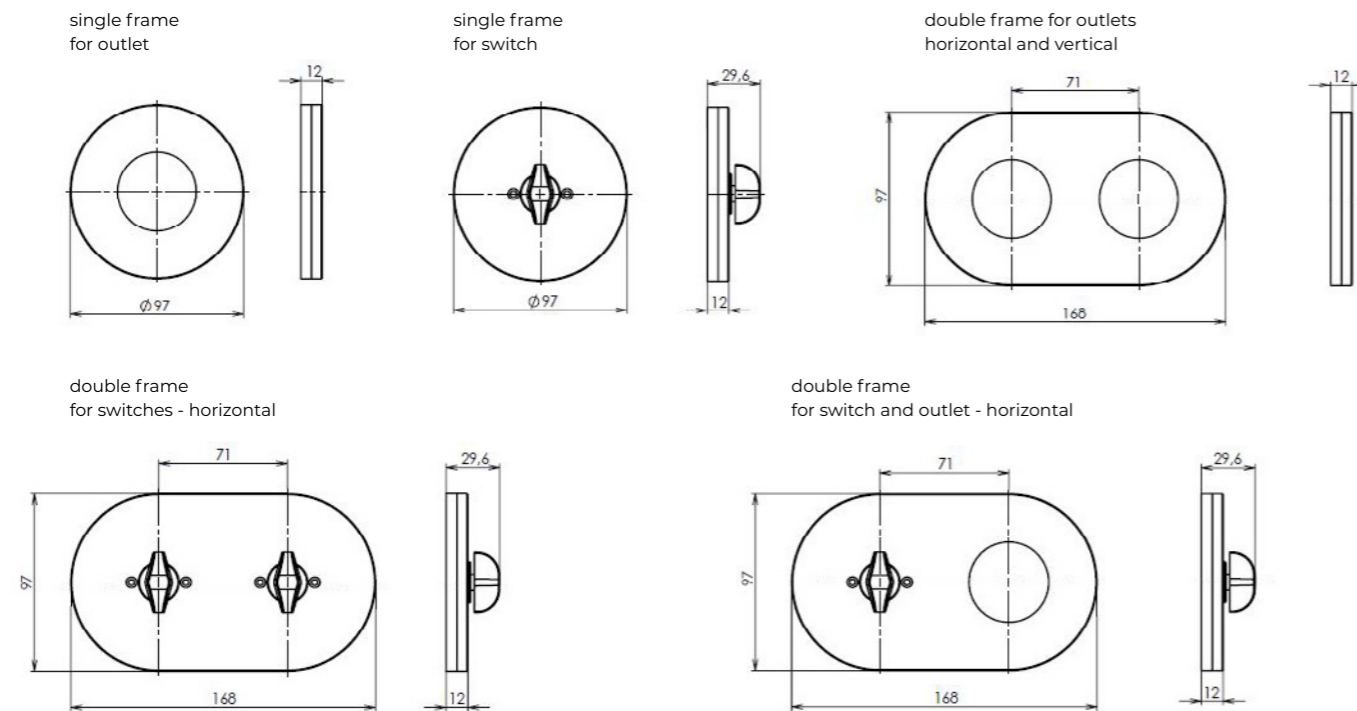

## retro

### fittings

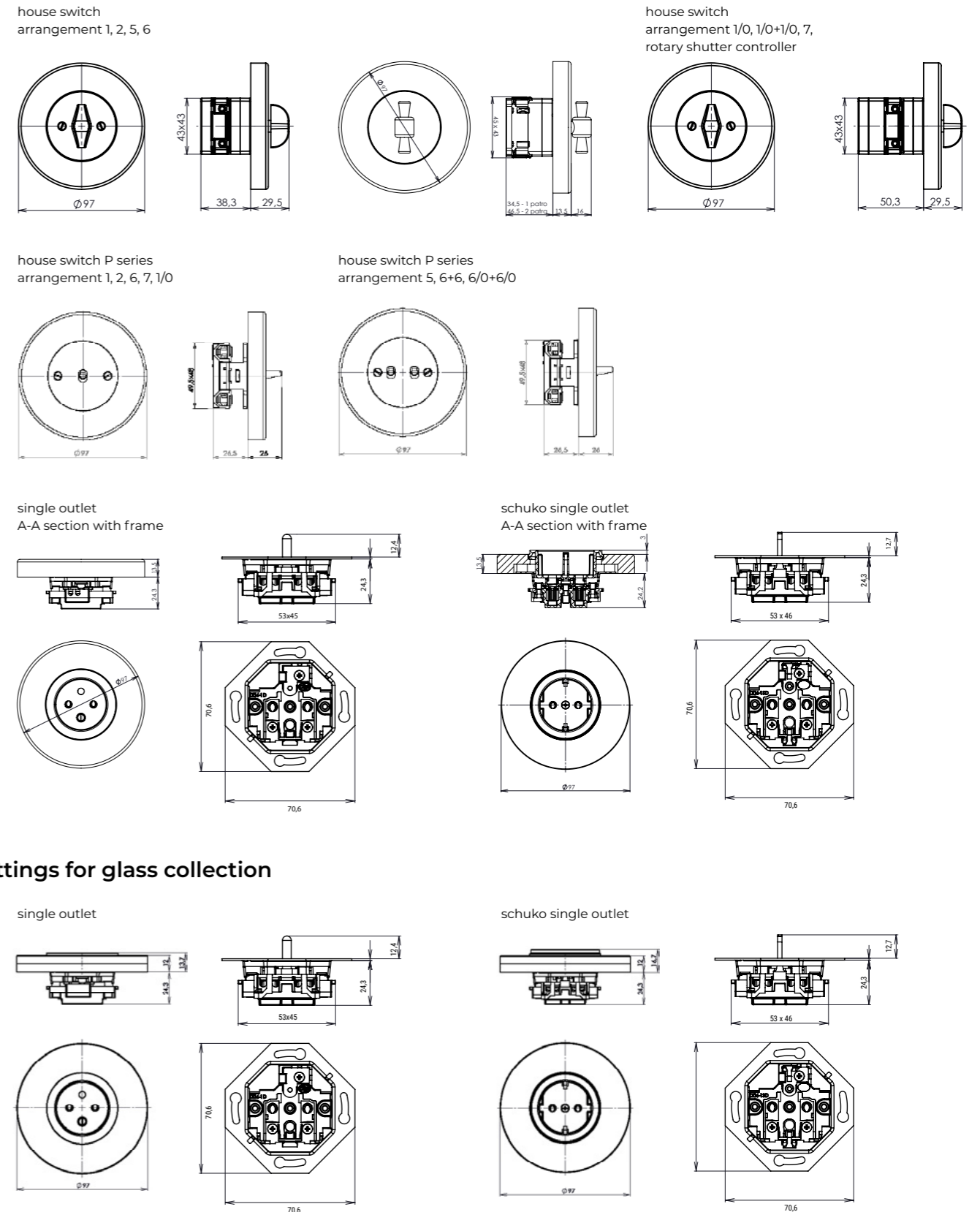

# retro

## fixtures

outlet with connector  
HDMI, USB, TV, SAT

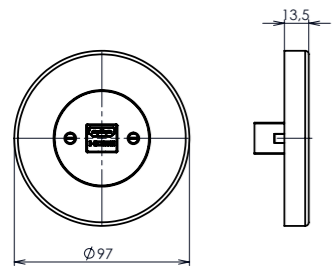

outlet with connector  
PC, RJ 45

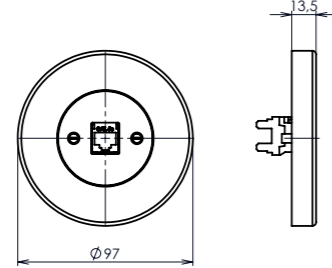

outlet with USB  
charging

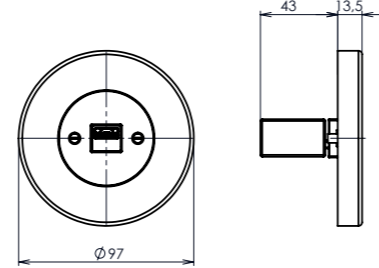

motion sensor B.E.C.  
glass, wood

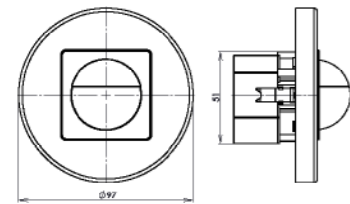
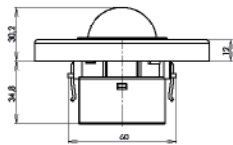

one level cam switch

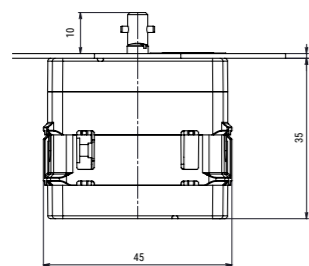
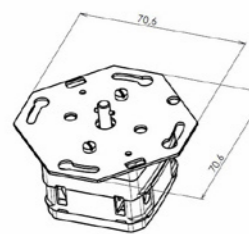

two level cam switch

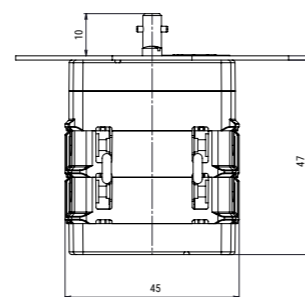
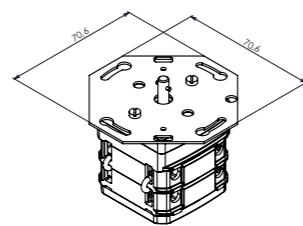

# decente

## frames

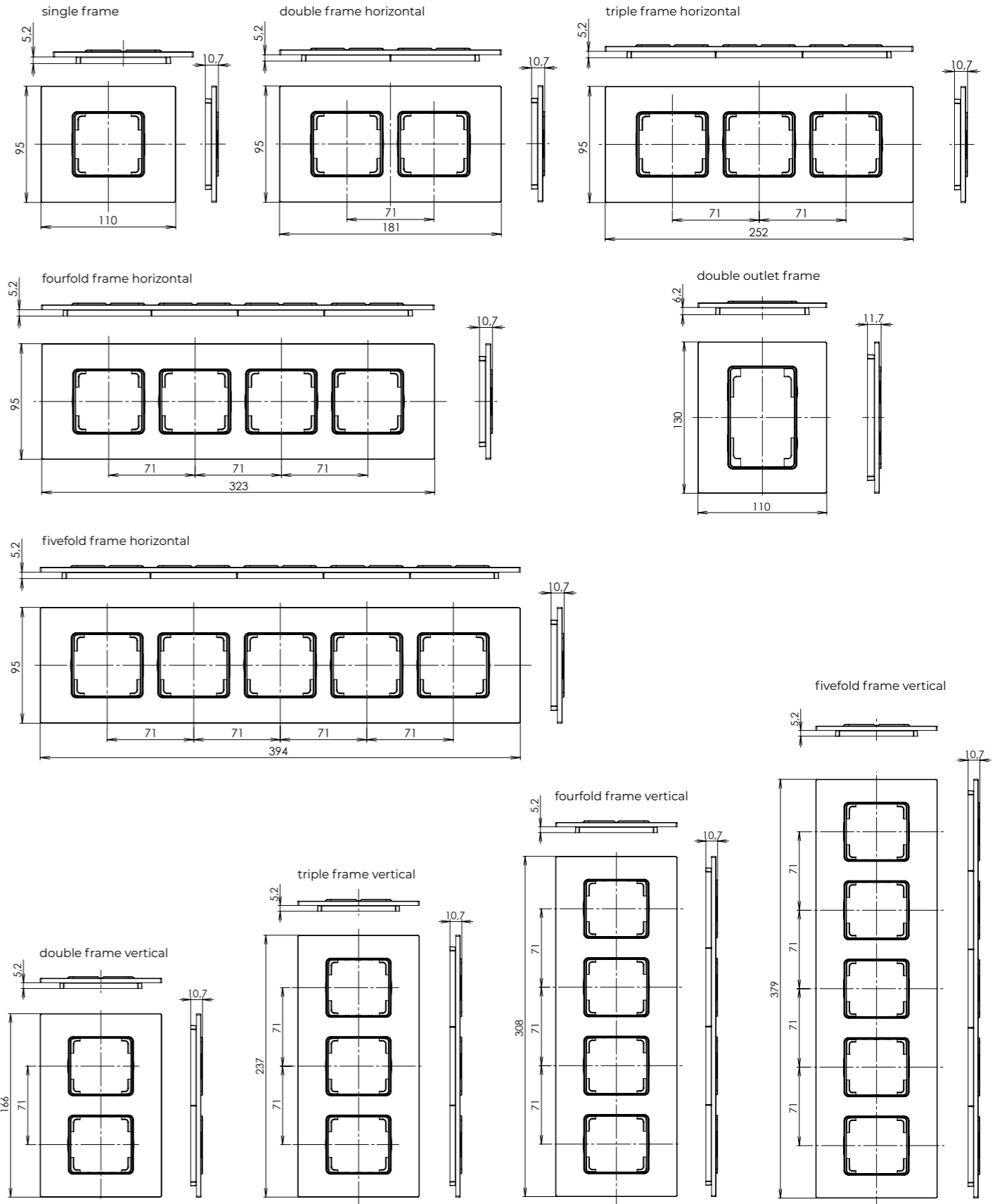



# decente

## fittings

switch with single cover

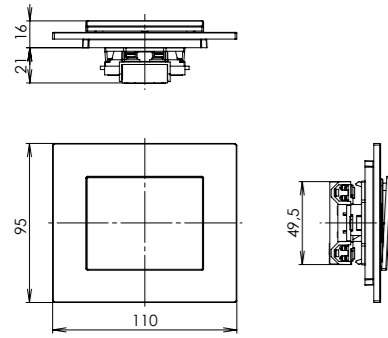

switch with single cover with backlighting

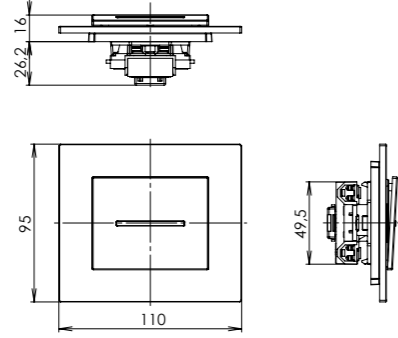

switch with double cover

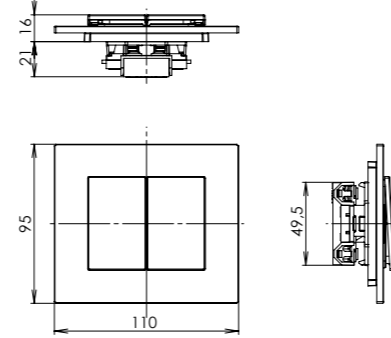

single outlet with safety shutters

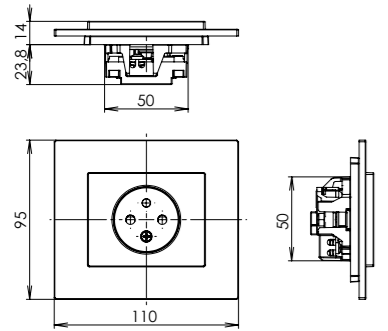

single outlet with safety shutters and overvoltage protection (light indication)

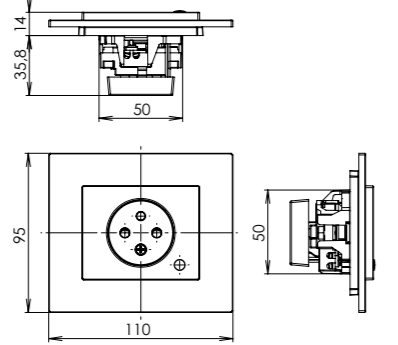

single outlet with safety shutters and overvoltage protection (audible alarm)

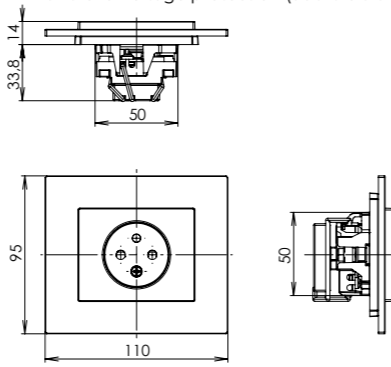

schuko single outlet with safety shutters

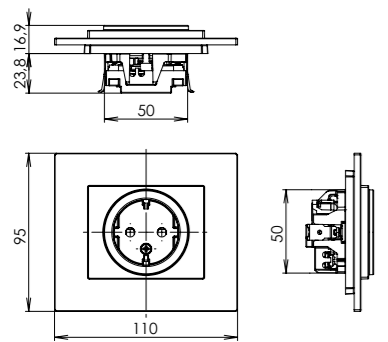

single outlet with safety shutters and overvoltage protection (light indication and audible alarm)

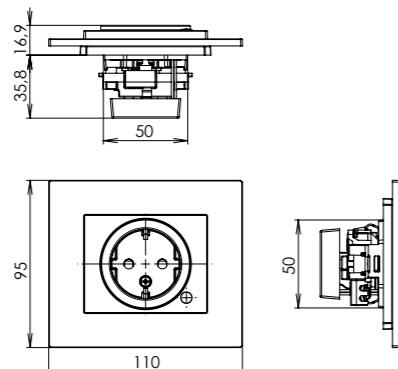

## fittings for glass collection

single outlet with safety shutters

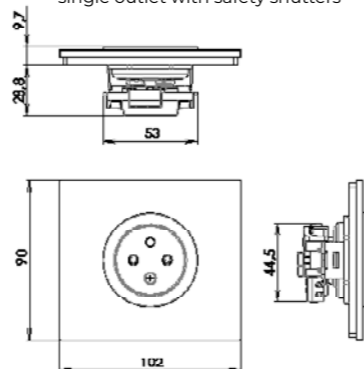

# decente

## fittings

double outlet with safety shutters

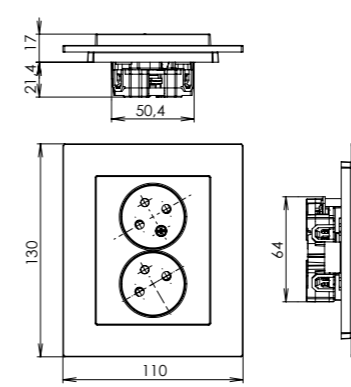

double outlet with safety shutters and overvoltage protection (audible alarm or light indication)

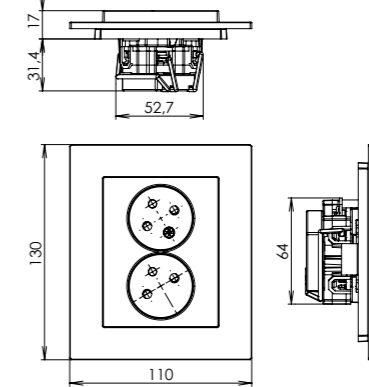

modular outlet USB with charger

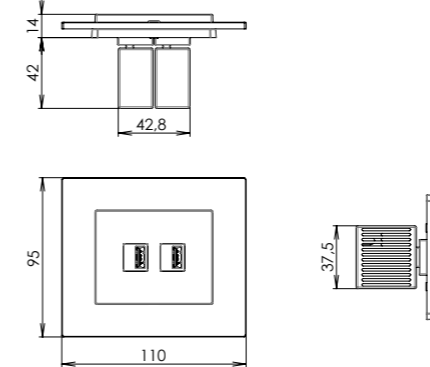

modular data outlet HDMI, USB, RJ45

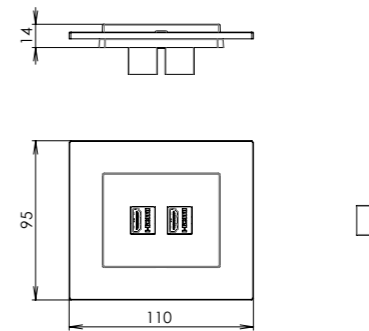

## fittings british standard

single outlet British standard

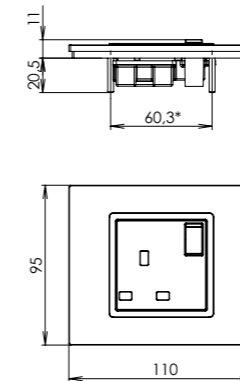

double outlet British standard

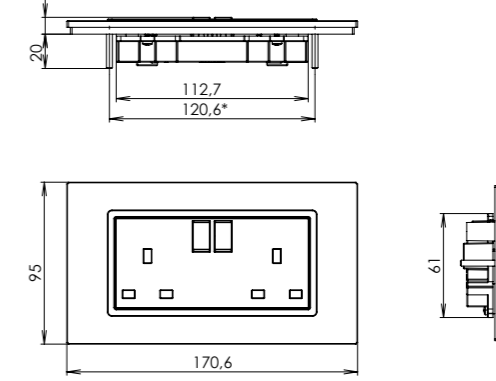

\* Needs to be installed into British installation boxes.

# decente

## fittings

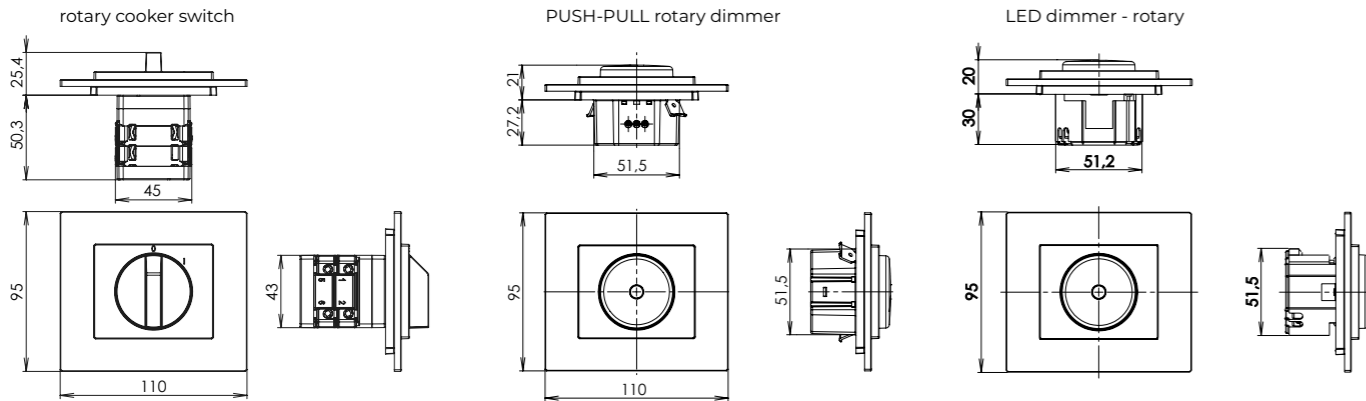

NOTE: greater mounting depth!

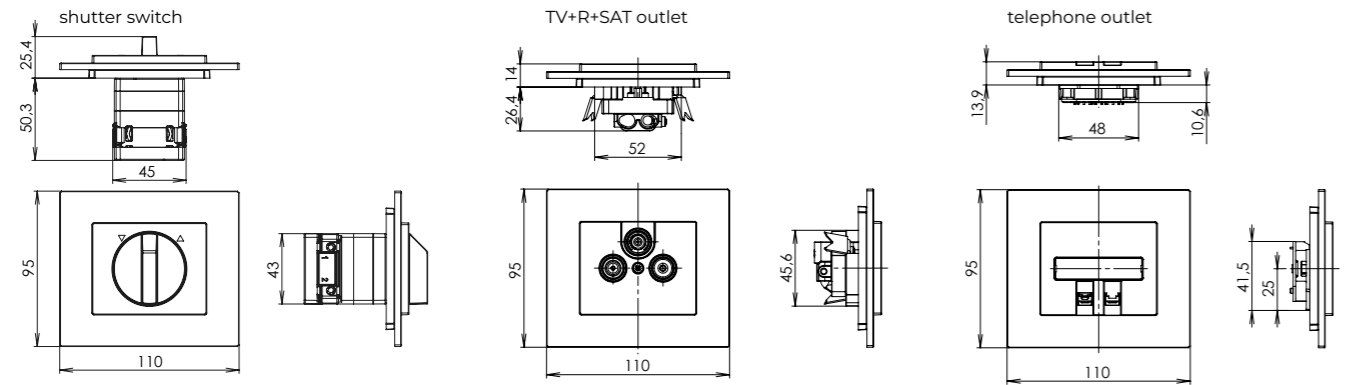

NOTE: greater mounting depth!

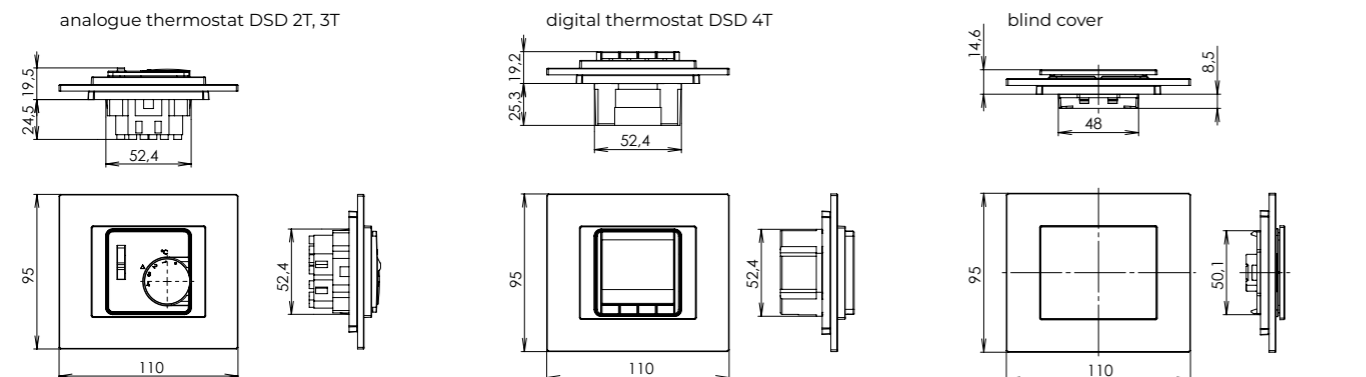
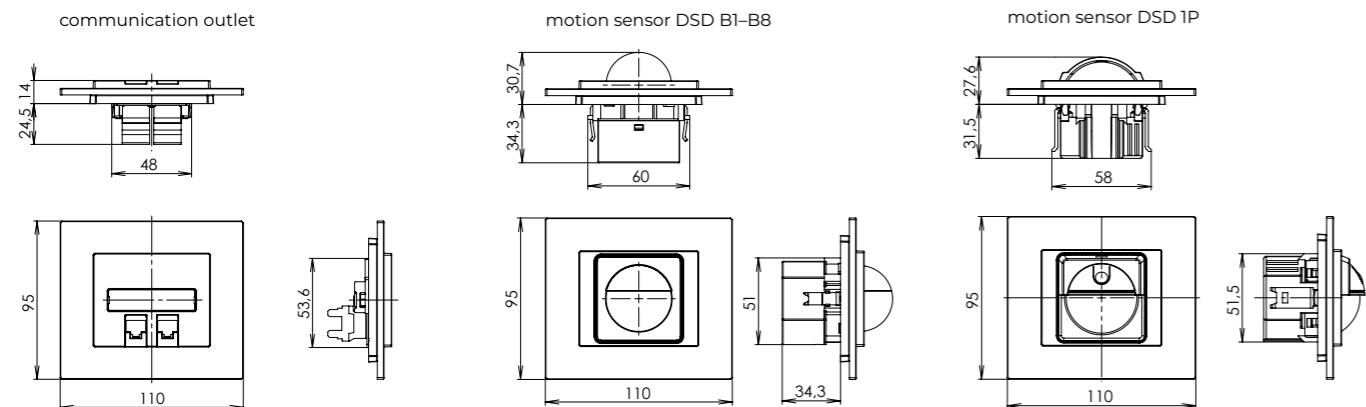

# vectis

## frames

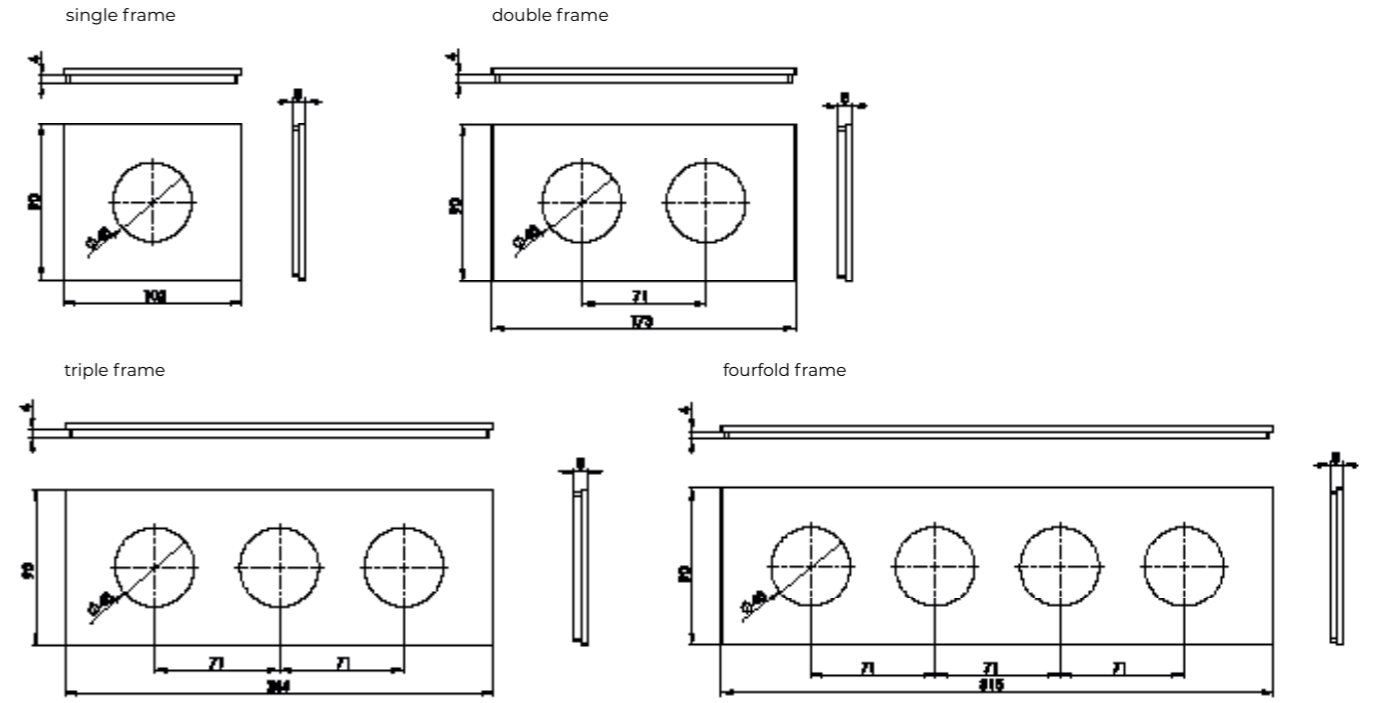

## fittings

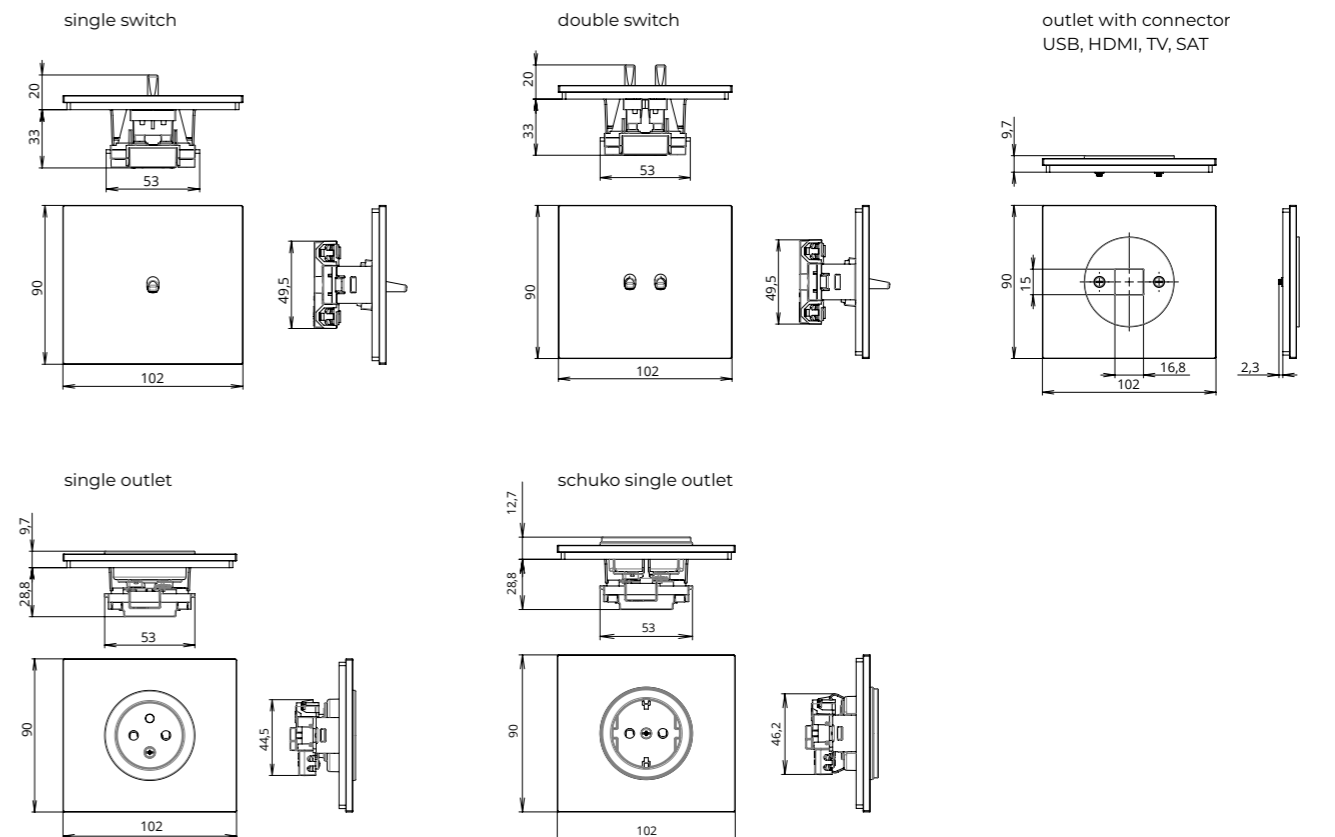

## vectis round

### frames

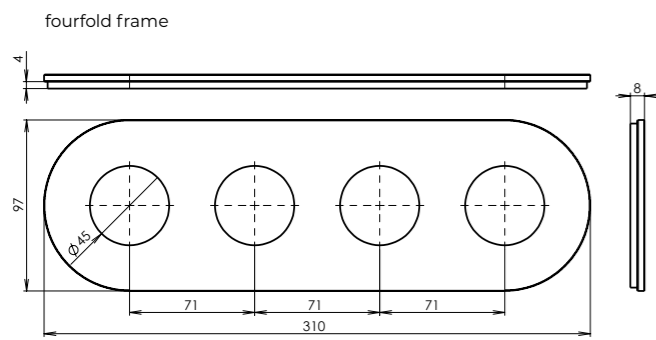
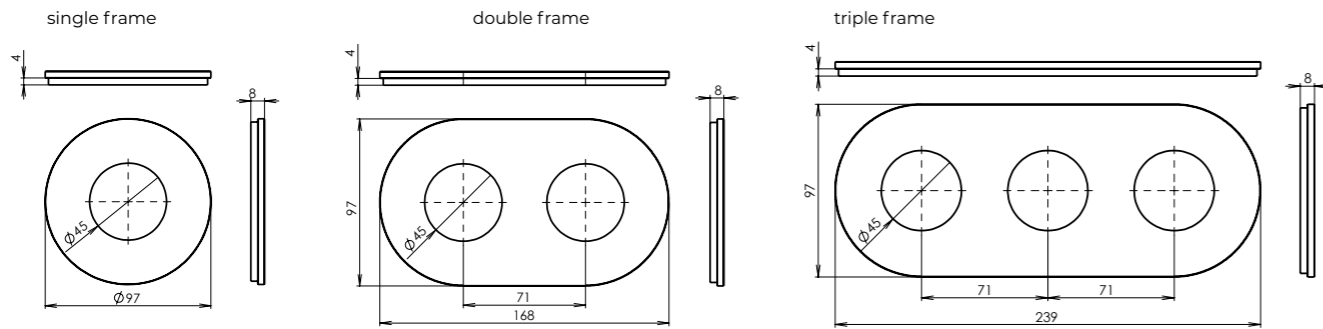

### fittings

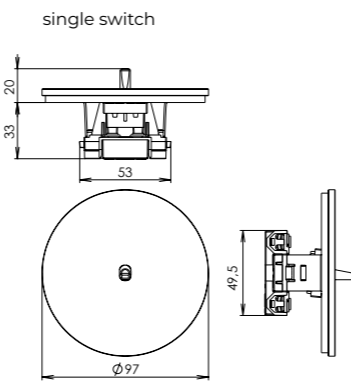

outlet with connector  
USB, HDMI, TV, SAT

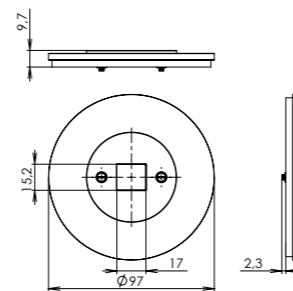

schuko single outlet

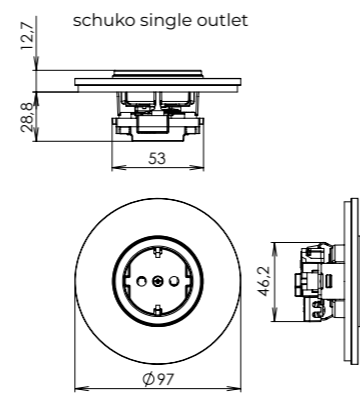

double switch

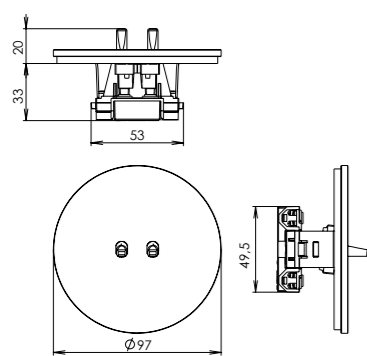

double switch, arrangement 7+7

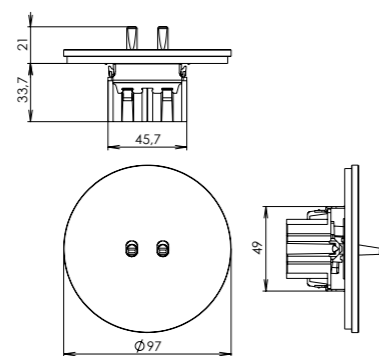

outlet with connector  
PC

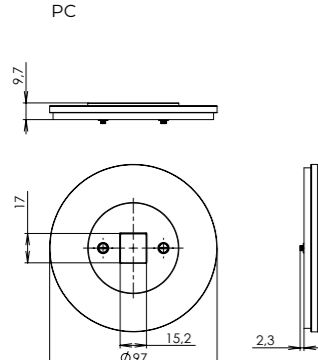

single outlet

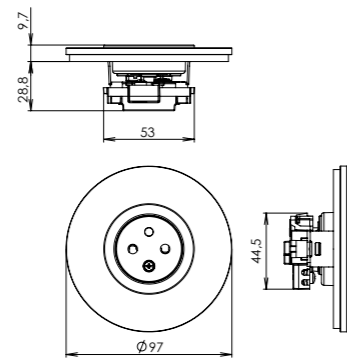

## elegant

### frames

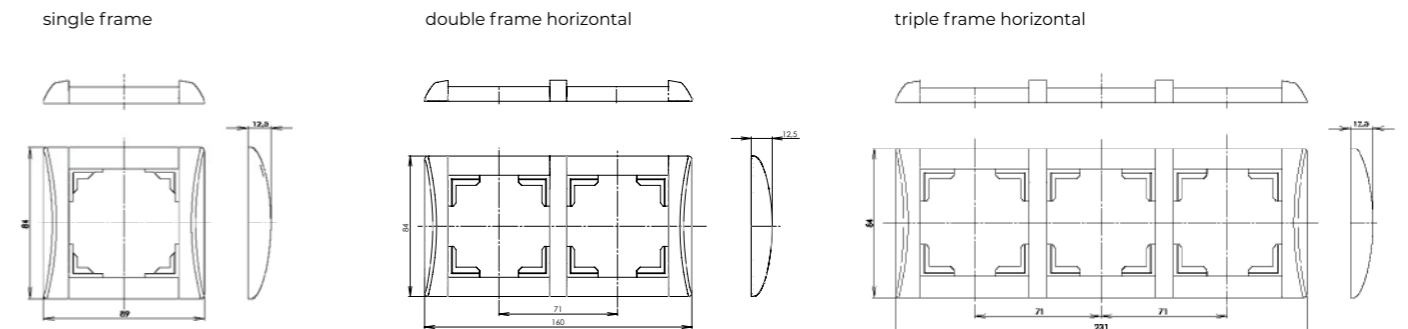

double frame vertical

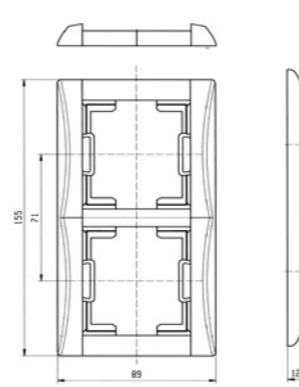

2x double frame vertical

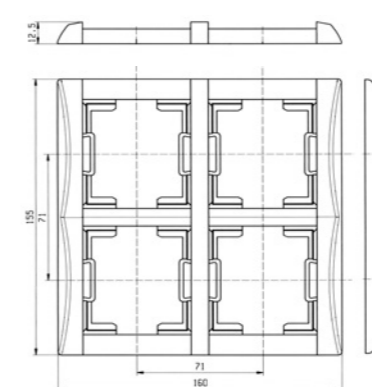

triple frame vertical

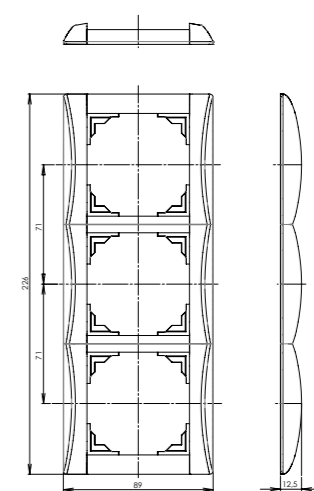

fourfold frame horizontal

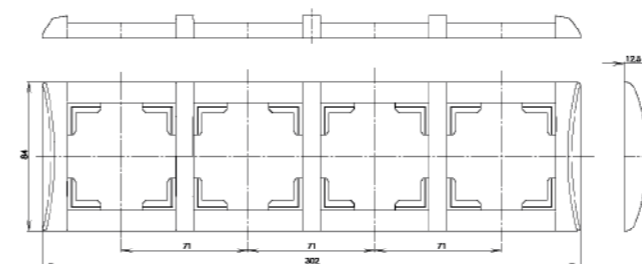

fivefold frame horizontal

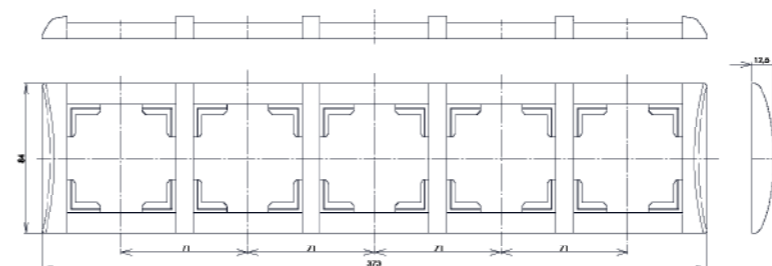

sixfold frame horizontal

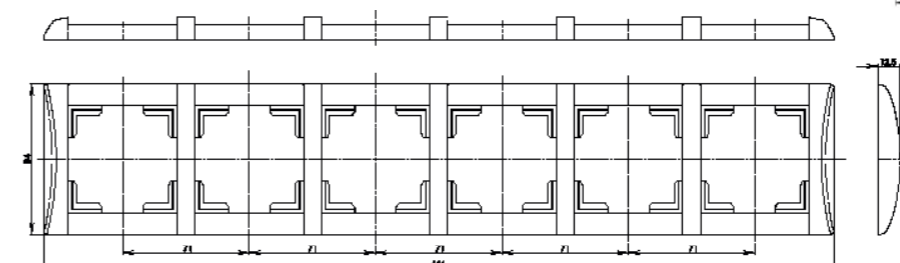

double outlet frame

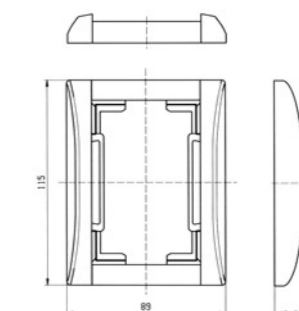

# elegant

## fittings

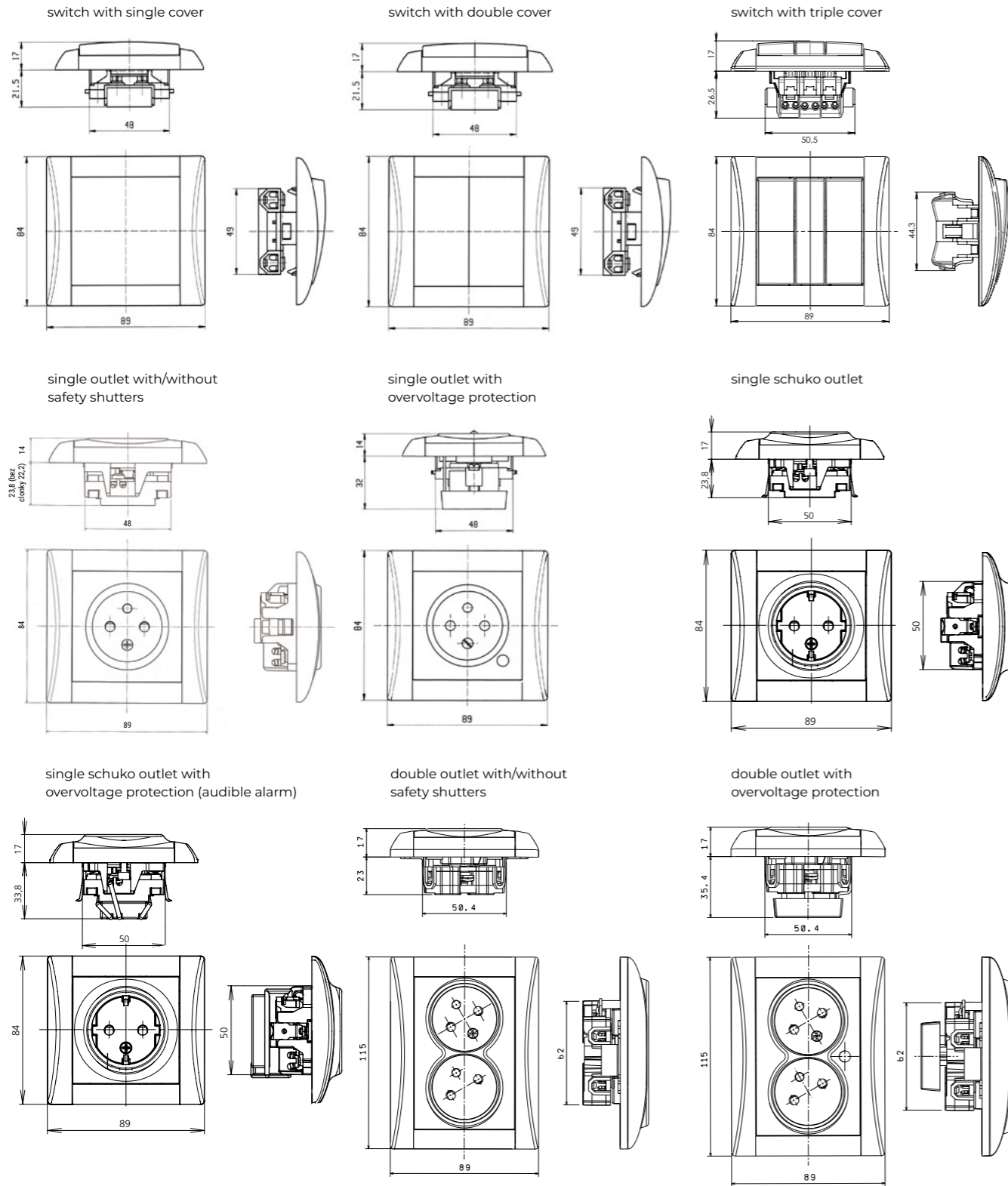

Double sockets must be installed in electrical installation no spout box at 6 and 12 o'clock.

# elegant

## fittings

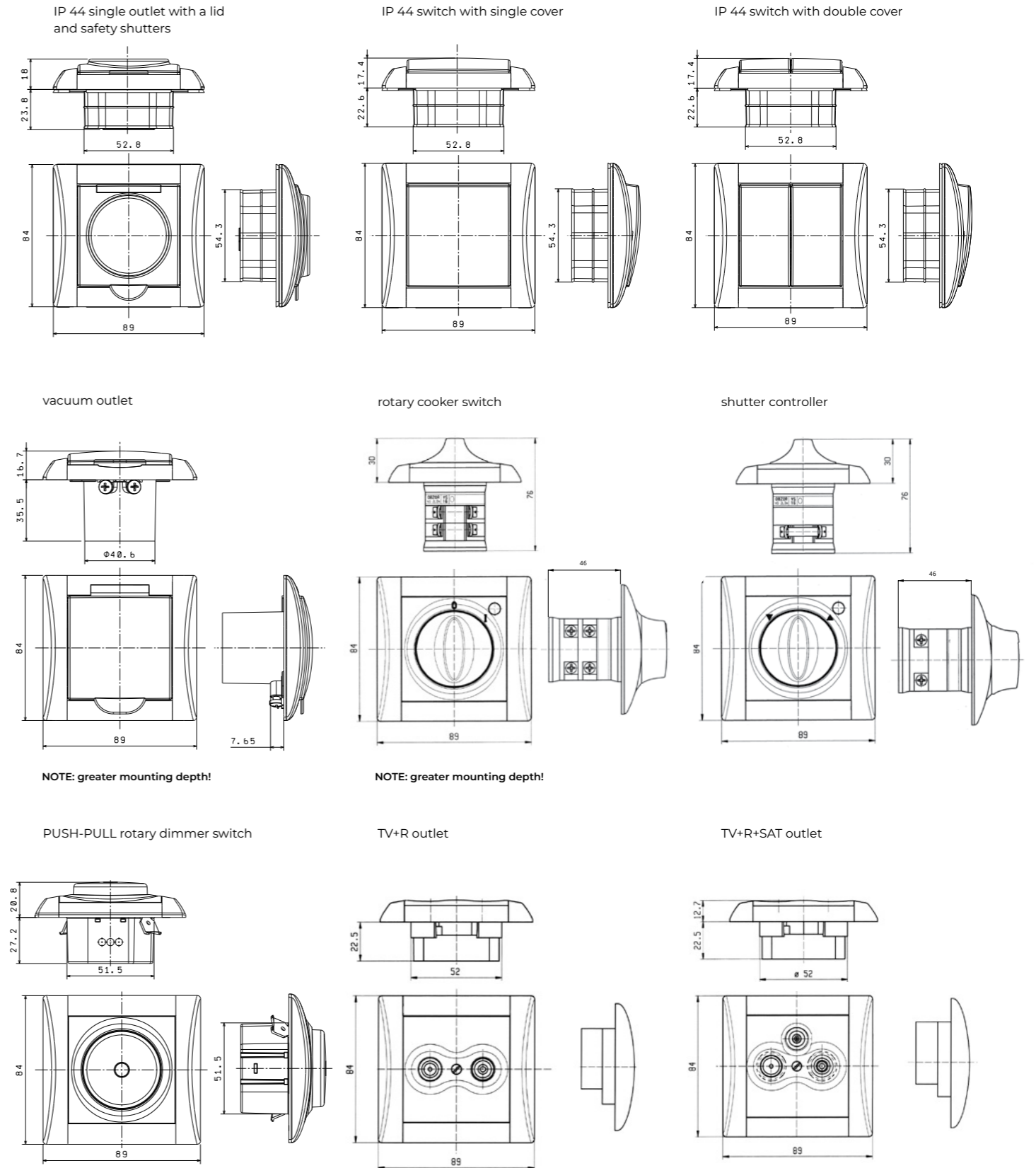

# elegant

## fittings

AUDIO-VIDEO outlet

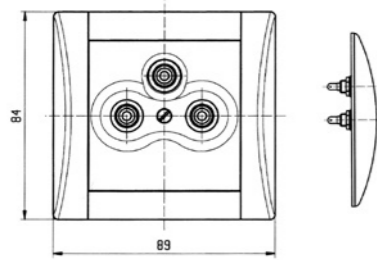
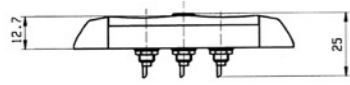

telephone outlet

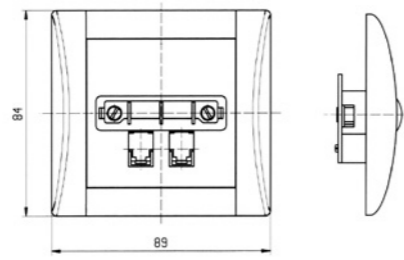
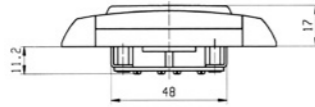

communication outlet

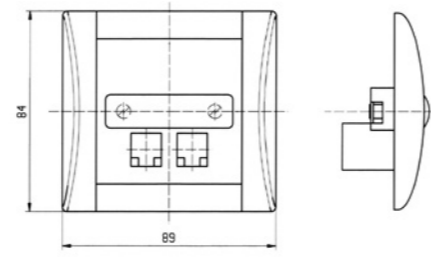
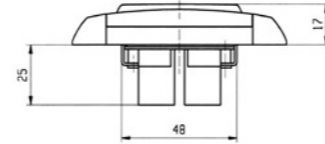

protective bonding outlet

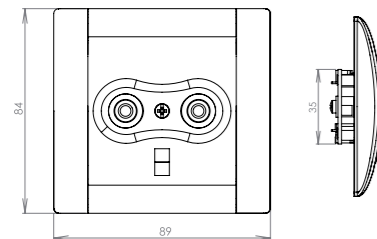
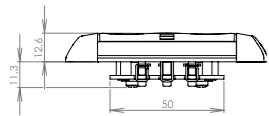

analog thermostat OREG/EBERLE DSE 2T/3T

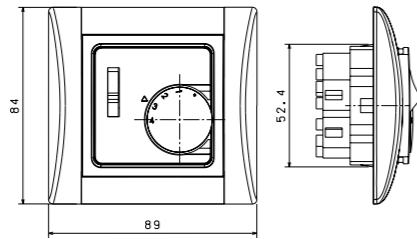
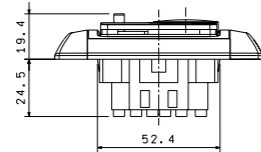

digital thermostat DSE 4T

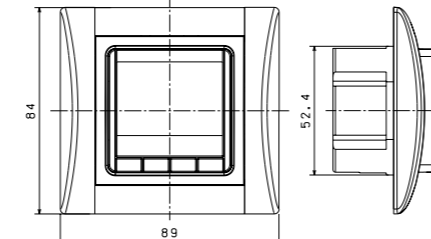
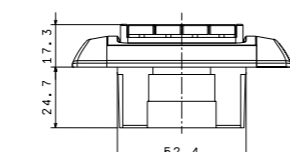

motion sensor STEINEL

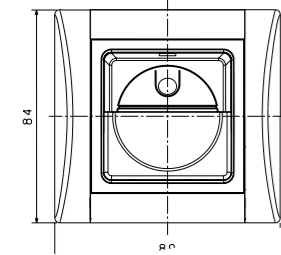
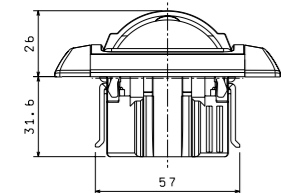

motion sensor B.E.G.

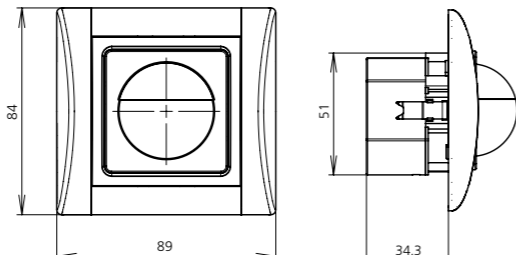
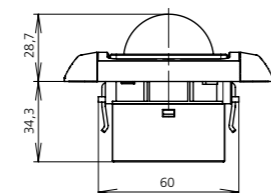

# elegant

## fittings

spacer ring VK1

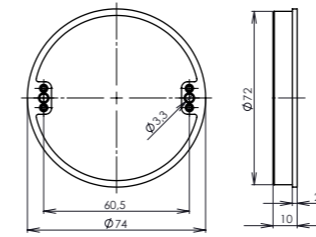

spacer ring VK2

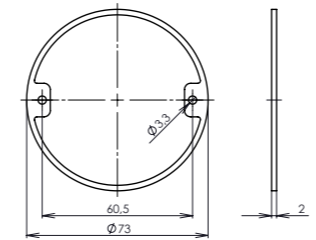

installation box, on-plaster

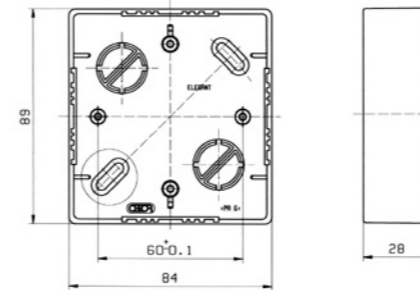

double outlet installation box, on-plaster

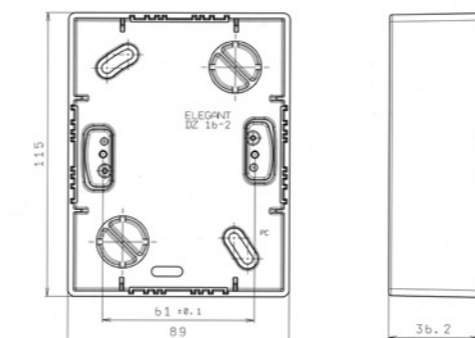

# variant

## frames

single frame

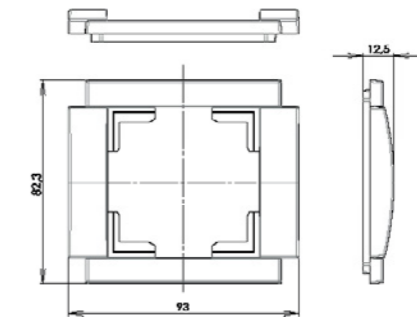

double frame horizontal

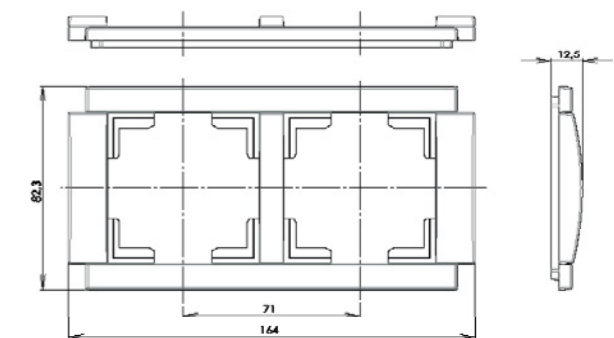

triple frame horizontal

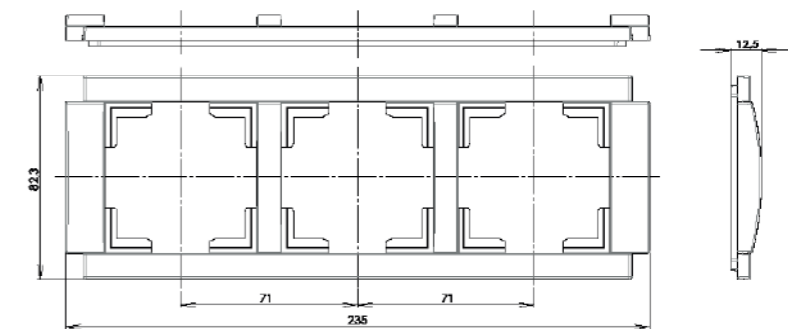

VARIANT and ELEGANT fittings are compatible.



issue 09/2022, subject to change

switches & outlets

OBZOR

**OBZOR Zlín**

Na Slanici 378

763 02 Zlín

Czech Republic

+420 577 195 138

+420 734 258 046

export@obzor.cz

**obzorzlin.com**

**domovnivypinace.cz/en**

