

OBZOR

switches & sockets

**technical
catalogue**

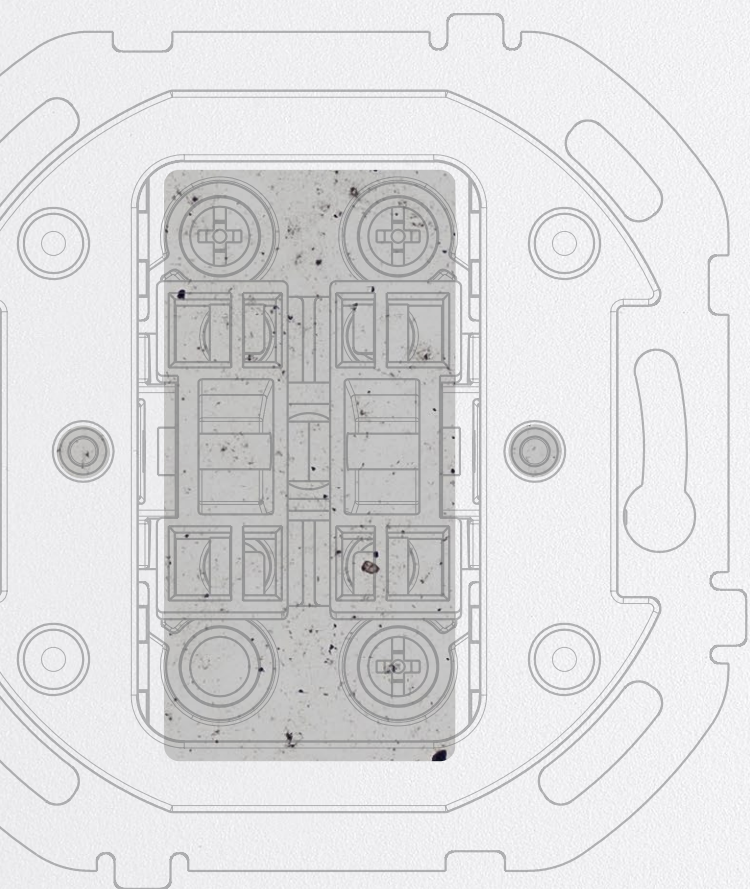

O3ZOR

switches & sockets
made in Czech Republic

content

about us	4
avant	9
nexa	15
retro	25
decente	39
decente hotel systems	48
elegant	51
elegant aqua IP 44	62
elegant vacuum sockets	64
elegant medical	67
thermostats and motion sensors	71
passive switches for intelligent systems	74
accessories	76
wiring diagrams	78
technical drawings	80

obzor

... tradition since 1965

OBZOR company was founded sixty years ago. During this time the company has established among the top manufacturers and distributors of small electromechanical products, automotive parts, metal and injection moulding parts. Year 2000 can be considered as the beginning of development and subsequent production of wiring products such as switches, sockets, drivers and more.

- Czech tradition, 100% ownership rooted in tradition, owned fully in Czech hands
- stability and quality
- traditional Czech manufacturer of cam switches, house wiring and accessories
- socially responsible company
- major supplier of plastic parts for automotive
- top equipment
- assembly of products



product lines

elegant / since 2003

A product line with a classic, unobtrusive design that offers a wide range of colours and combinations. The unique design of the frame allows two colours to be combined — one on the side segment and one on the base segment of the frame. An unusual frame-joining concept also makes it possible to create vertical, modular, or even up to seven times horizontal combinations.

- The product range includes**
- switches, sockets, controllers
 - vacuum sockets
 - aqua sockets and switches with IP 44 protection
 - thermostats, PIR sensors
 - medical series sockets for healthcare industry

product lines

decente / since 2011

This timeless product line uses natural noble materials – glass, wood, metal, concrete and plexiglass. These prime frames can be combined up to four-fold horizontal and vertical. Between 2014–2015, Decente range has expanded with new glass frame colours, matt frames, and more affordable PLEXIGLASS version in white or black.

- The product range includes**
- switches, sockets, controllers
 - thermostats, PIR sensors
 - passive switches for smart home systems
 - data sockets
 - DECENTE hotel systems

retro / since 2017

Switches of RETRO line feature an original design inspired by rotary switches from the 1930s and unique functionalist architecture of Zlín city. Round frames are made of solid wood, ceramics, glass or concrete and are also available in horizontal / vertical double or triple versions. Switches are controlled by an unusual handle. They are suitable not only for rustic, but also for minimalist and industrial interiors. RETRO series contains wide range of fittings according to current standards for a comfortable living.

- The product range includes**
- switches, sockets, controllers
 - data sockets
 - thermostats and motion sensors

nexa rondo / since 2024

nexa quadro / since 2026

A new series that builds on the successful RETRO toggle switches. The biggest difference is the material used - timeless and always elegant glass in black and white. It also differs from the existing frames in size and strength. Compared to the original thickness of 13.5 millimetres, it is now only eight millimetres thick. For lovers of natural design, the wood frames are available in maple and oak.

- The product range includes**
- switches, sockets, controllers
 - data sockets
 - thermostats
 - passive switches for smart home systems

avant / since 2025

Avant is an innovative range of switches designed for those who want to combine modern design with maximum practicality. Elegant shapes, quality materials and easy operation make every press a pleasant experience. The switch frames are made of high-quality aluminium, ensuring not only durability but also adding a light aesthetic element to every room.

- The product range includes**
- switches, sockets, controllers
 - data sockets
 - thermostats
 - passive switches for smart home systems

assembly of fittings composition of ordering code

In case of a demand of a single frame set, fittings can be specified by a composite assembly code with the following definition:

elegant

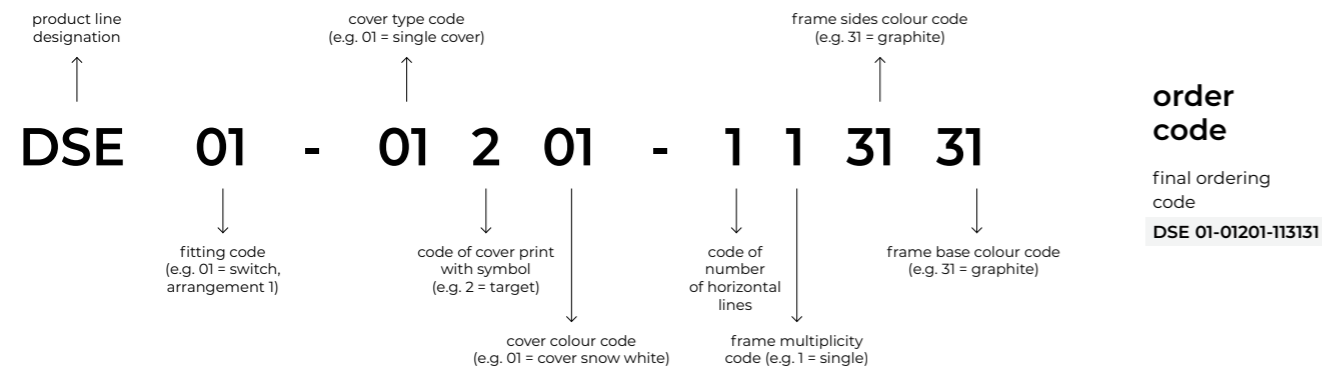
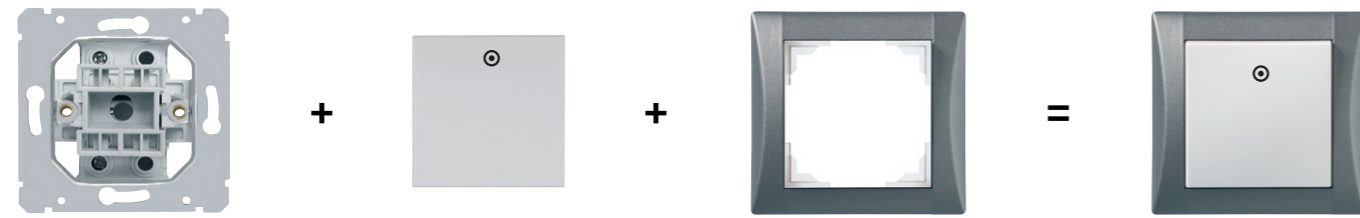

retro

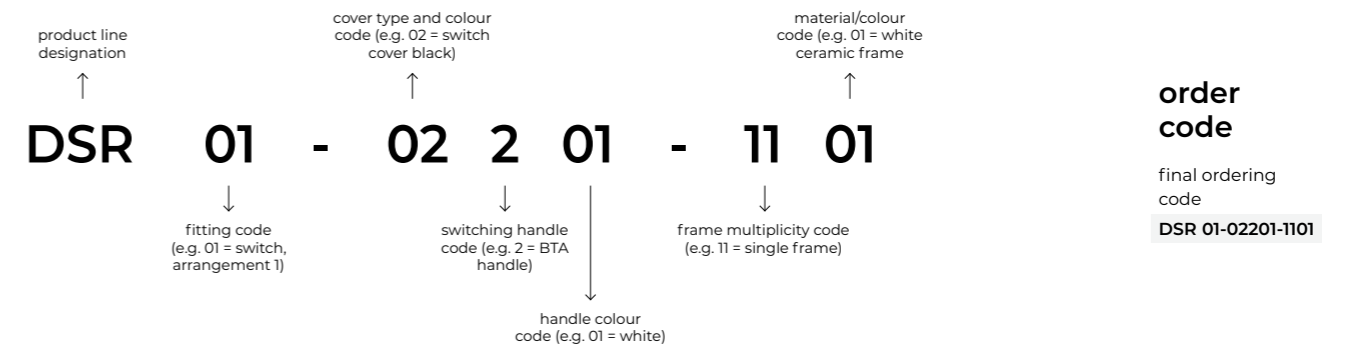

decente

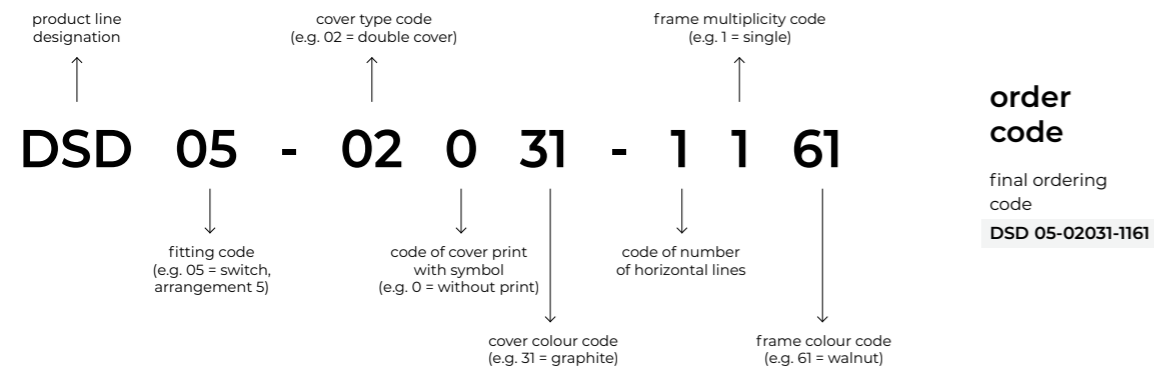
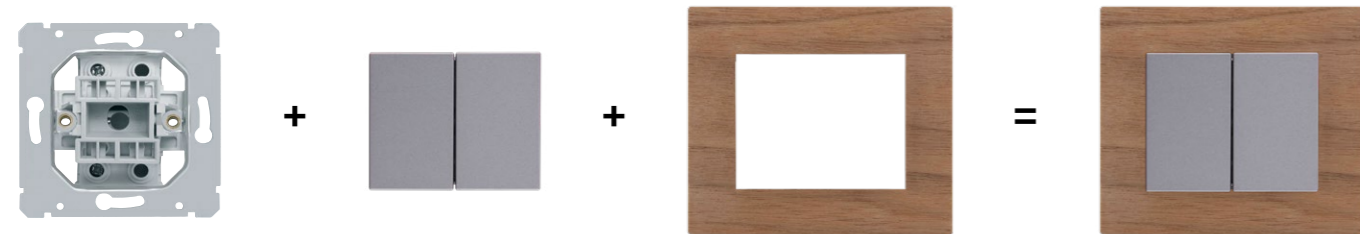

nexa

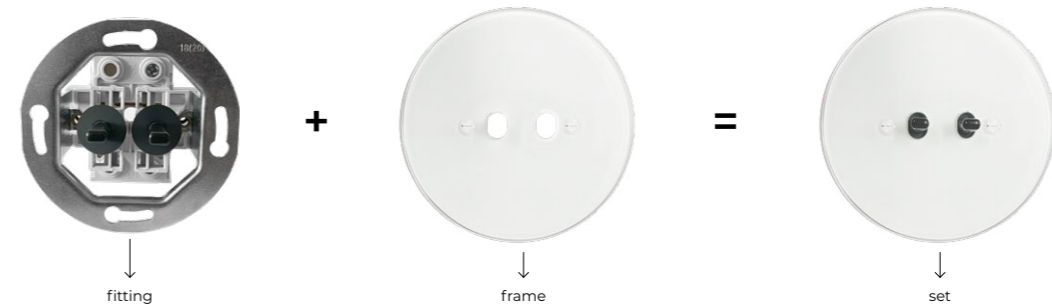

avant

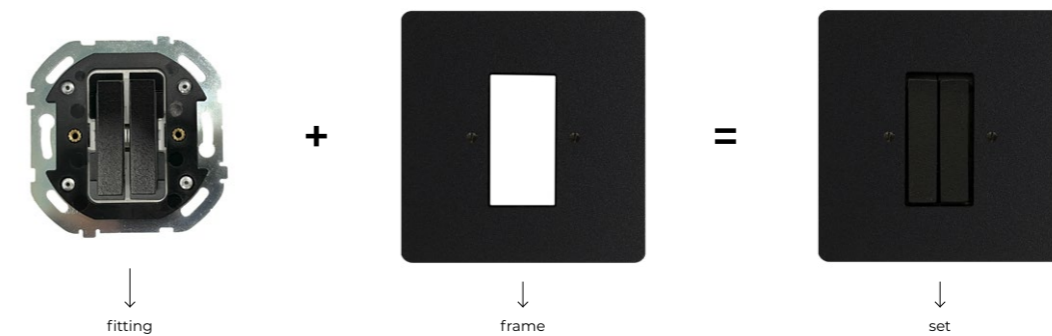

NEXA and AVANT fittings and frames need to be ordered separately as there is no possibility to create codes for sets.



avant

*unconventional
design*



Avant is an innovative range of switches, designed for those who want to combine modern design with maximum practicality. Elegant shapes, quality materials and easy operation make every press a pleasant experience. The switch frames are made of high-quality aluminium, ensuring not only durability but also adding a light aesthetic element to every room.

aluminium collection

A new design series of switches and sockets, that thanks to progressive sockets, will elevate your space to a new level and highlight the beauty of modern interiors, thanks to progressive craftsmanship. The main design feature is the rocker switch control, which gives the switches a sophisticated look while allowing comfortable and intuitive control of the lights.



aluminium white frame / rocker switch control white



aluminium black frame / rocker switch control black



aluminium black frame / sockets cover black matt

sets



single toggle switch (arrangement 1, 2, 6, 7, 1/0), press button up to 24V



single toggle switch (arrangement 5, 6+6, 1/0+1/0), shutter switch, press button up to 24V

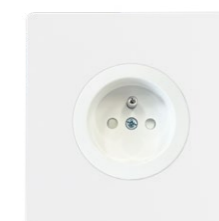

single sockets

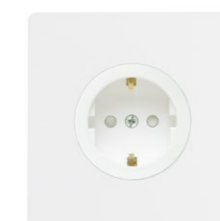

schuko single sockets



TV + SAT sockets



2x PC sockets



2x USB-A charging sockets



USB-A + USB-C charging sockets



2x USB-C charging sockets



USB-A charging sockets



EBERLE digital thermostat universal (application as floor and combined, it is necessary to buy a sensor)



EBERLE analogue ROOM / FLOOR thermostat under plaster mounting (with sensor)

covers



01 white
35 white matt



02 black
34 black matt

frames

aluminium



01 white

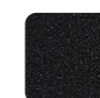

02 black

metal



01 white









02 black

rocker switch controls





* Illustrative photo - any data connector can be selected from the range Accessories.





frame multiplicities

						dimensions (h*w) 90*90 mm
DSA RA-10000-11xx	DSA RA-20000-11xx	DSA RA-30000-11xx	DSA RA-40000-11xx	DSA RA-50000-11xx	DSA RA-60000-11xx	
			frame for data socket	frame for 2* data sockets	frame for blind cover	
						
DSA RA-T0000-11xx						
frame for thermostat						

horizontal















					dimensions (h*w) 90*161 mm
DSA RA-11000-12xx	DSA RA-22000-12xx	DSA RA-33000-12xx	DSA RA-12000-12xx	DSA RA-13000-12xx	
					
DSA RA-11100-13xx	DSA RA-33300-13xx	DSA RA-13300-13xx			

vertical



					dimensions (h*w) 161*90mm
DSA RA-11000-21xx	DSA RA-22000-21xx	DSA RA-33000-21xx	DSA RA-12000-21xx	DSA RA-13000-21xx	

Other combinations of multiple frames can be custom made.



horizontal | custom made

				dimensions (h*w) 90*161 mm	
DSA RA-24000-12xx	DSA RA-23000-12xx	DSA RA-44000-12xx	DSA RA-14000-12xx		
					dimensions (h*w) 90*232 mm
DSA RA-22300-13xx	DSA RA-11400-13xx	DSA RA-11300-13xx	DSA RA-33400-13xx	DSA RA-44400-13xx	
					
DSA RA-22200-13xx	DSA RA-23300-13xx	DSA RA-24300-13xx	DSA RA-14300-13xx	DSA RA-12400-13xx	

vertical | custom made



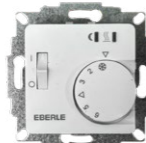













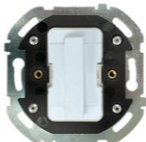

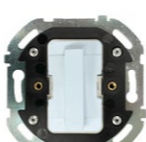
					dimensions (h*w) 161*90mm
DSA RA-14000-21xx	DSA RA-23000-21xx	DSA RA-24000-21xx	DSA RA-44000-21xx		

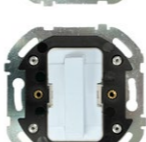
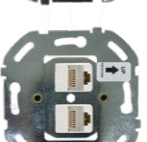
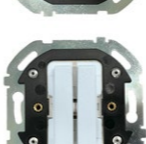
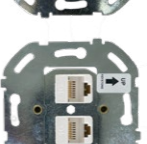
fittings / sockets

	EBERLE analogue ROOM thermostat under plaster mounting DSA 2T-00000		EBERLE analogue FLOOR thermostat under plaster mounting, with sensor DSA 3T-00000		EBERLE digital thermostat universal DSA 4T-00000
--	--	---	--	--	---

i When selecting a universal digital thermostat and connecting it as a floor thermostat, it is necessary to purchase the floor sensor DSA 56 separately. More information about thermostats can be found on page 72.
WARNING: For vertical installation, use installation boxes designed for double or triple frames; do not use separate connected boxes.

fittings / sockets

	fitting, arrangement 1 singlepole switch, 10 AX, 250 V AC DSA 01-00001 white DSA 01-00002 black		sockets single, cover white safety shutters 16 A, 250 V AC DSA Z1-Z1001 white DSA Z1-Z1035 white matt DSA Z1-Z1002 black DSA Z1-Z1034 black matt
	fitting, arrangement 2 twopole switch, 10 AX, 250 V AC DSA 02-00001 white DSA 02-00002 black		sockets schuko single, cover white safety shutters 16 A, 250 V AC DSA SI-S1001 white DSA SI-S1035 white matt DSA SI-S1002 black DSA SI-S1034 black matt
	fitting, arrangement 5 serial change-over switch, 10 AX, 250 V AC DSA 05-00001 white DSA 05-00002 black		2x USB-A charging sockets 2x connector:: USB - charging, 2,1 A, 10,5 W DSA 96-00001 keystone white DSA 96-00002 keystone black
	fitting, arrangement 6 AC change-over switch, 10 AX, 250 V AC DSA 06-00001 white DSA 06-00002 black		2x USB-C charging sockets 2x connector:: USB - charging, 2,1 A, 10,5 W DSA 9C-00001 keystone white DSA 9C-00002 keystone black
	fitting, arrangement 7 crossbar switch, 10 AX, 250 V AC DSA 07-00001 white DSA 07-00002 black		TV + SAT sockets 1 connector:: female, Z=75 Ω DSA 97-00001 keystone white DSA 97-00002 keystone black
	fitting, arrangement 1/0 switching controller, 10 AX, 250 V AC DSA 10-00001 white DSA 10-00002 black		2x PC Cat. 5E sockets 2x connector:: RJ 45 cat. 5E, UTP DSA 93-00001 keystone white DSA 93-00002 keystone black
	fitting, arrangement 1/0+1/0 switching controller, double, 10 AX, 250 V AC could be used as a blind controller without blocking DSA 11-00001 white DSA 11-00002 black		2x PC Cat. 6 sockets 2x connector:: RJ 45 cat. 6, UTP DSA 98-00001 keystone white DSA 98-00002 keystone black
	fitting, arrangement 6+6 switching controller, double, 10 AX, 250 V AC DSA 66-00001 white DSA 66-00002 black		passive switch for intelligent systems with 1 rocker switch control 12 V DC/ 24 V DC depending on type DSA KC-01001 white DSA KC-01002 black
	press button switch 1/0 press button, up to 24V 50 mA, 24 V DC DSA 17-00001 white DSA 17-00002 black		passive switch for intelligent systems with 2 rocker switch controls 12 V DC/ 24 V DC depending on type DSA KC-02001 white DSA KC-02002 black
	press button switch 1/0+1/0 Up to 24 V, with gold plated contacts up to 50 mA, 24 V DC DSA 18-00001 white DSA 18-00002 black		support frame for blind cover DSA 60-00000
	fitting for shutter controller 10 AX, 250 V AC DSA 16-00001 white DSA 16-00002 black		support frame for data sockets DSA 90-00000

i The rockers are part of switching mechanisms. Passive short press switch for intelligent systems can also be used for KNX systems. Any connector from the accessories on page 76 can be selected for the support frame.



nexa

*minimalistic
design*



Nexa, design series of switches and sockets, inspired by the RETRO toggle series, presenting a perfect blend of minimalism and functionality for any space. The frame material features high-quality glass in practical white and black finishes, as well as wooden frames for those seeking a natural design. Setting it apart from the RETRO series is the size and thickness of the frame, measuring 86 mm in diameter and 8 mm in thickness, providing modern and minimalist vibes to interiors.



nexa rondo

It is characterized by clean and simple shapes that emphasize the beauty of glass and wood. The switches are designed with an emphasis on minimalist style and ergonomic design, giving the interior a modern look.



glass white frame
/ double toggle white



wooden light oak frame
/ single toggle white



glass black frame
/ sockets cover black matt

nexa quadro

It combines the timeless beauty of wood and glass with the modern appearance of metal. Each piece is carefully crafted to blend traditional craftsmanship with premium design, creating a unique spatial element. The devices are universal for both collections of the NEXA series.



glass black frame
/ double toggle black

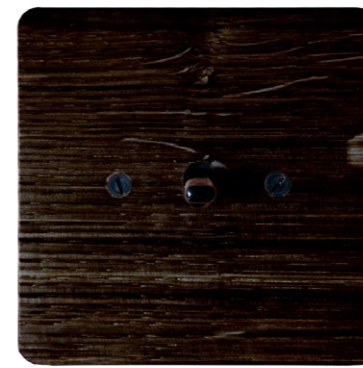

wooden dark stained oak frame
/ single toggle black



glass white frame
/ sockets cover white matt



sets | nexa rondo



single toggle switch
(arrangement 1, 2, 6, 7, 1/0),
press button up to 24 V



single toggle switch
(arrangement 5, 6+6, 1/0+1/0),
shutter switch,
press button up to 24 V



single sockets



schuko
single sockets



TV outlet, SAT, PC sockets
cat. 5E / cat.6

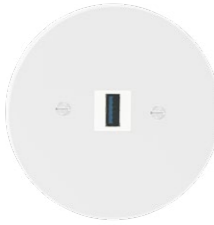

USB-A sockets
/ USB-A charging sockets

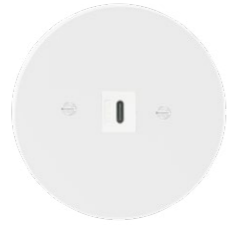

USB-C charging
sockets



single sockets british
standard in a glass frame



single sockets british
standard in a wooden frame



double sockets british standard
in a glass frame

frames

glass



01
white



02
black

toggles

metal



white



black

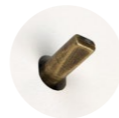

patina

wood **



23*
maple



21
light
oak



22*
dark
stained oak

sets | nexa quadro



single toggle switch
(arrangement 1, 2, 6, 7, 1/0),
press button up to 24 V



single toggle switch
(arrangement 5, 6+6, 1/0+1/0),
shutter switch,
press button up to 24 V



single sockets



schuko
single sockets



TV outlet, SAT, PC sockets
cat. 5E / cat.6



USB-A sockets
/ USB-A charging outlet



USB-C charging
sockets



single sockets british
standard in a glass frame



double sockets british
standard in a wooden frame



EBERLE analogue
ROOM/FLOOR thermostat
under plaster mounting
(with sensor)



EBERLE digital thermostat
universal (application as floor
and combined, it is
necessary to buy a sensor)

covers



01
white



02
black



34
black
matt















* Available by order only.
** For wooden frames we use only solid wood therefore each frame is unique and tone/pattern might slightly vary.
IMPORTANT: The british standard socket in the rondo collection must be installed in a round installation box.





















When selecting a universal digital thermostat and connecting it as a floor thermostat, it is necessary to purchase the floor sensor DSN 56 separately. More information about thermostats can be found on page 72.

frame multiplicities











 nexa rondo  nexa quadro

rondo	 DSN RN-10000-11xx	 DSN RN-20000-11xx	 DSN RN-30000-11xx	 DSN RN-40000-11xx	 DSN RN-60000-11xx	 DSN RN-A0000-11xx	dimensions (h*w) 86*86 mm
quadro	 DSN RQ-10000-11xx	 DSN RQ-20000-11xx	 DSN RQ-30000-11xx	 DSN RQ-40000-11xx	 DSN RQ-60000-11xx	 DSN RQ-A0000-11xx	
quadro	 DSN RQ-T0000-11xx frame for thermostat (only in the quadro range)						frame for socket and british standard socket in a wooden frame
				frame for data socket	frame for blind cover	frame for british standard socket in a glass frame	

horizontal













rondo	 DSN RN-11000-12xx	 DSN RN-22000-12xx	 DSN RN-33000-12xx	 DSN RN-12000-12xx	 DSN RN-13000-12xx	 DSN RN-AA000-12xx	dimensions (h*w) 86*157 mm
quadro	 DSN RQ-11000-12xx	 DSN RQ-22000-12xx	 DSN RQ-33000-12xx	 DSN RQ-12000-12xx	 DSN RQ-13000-12xx	 DSN RQ-AA000-12xx	
rondo	 DSN RN-11100-13xx	 DSN RN-33300-13xx	 DSN RN-13300-13xx			frame for double british socket in a glass frame	dimensions (h*w) 86*228 mm
quadro	 DSN RQ-11100-13xx	 DSN RQ-33300-13xx	 DSN RQ-13300-13xx				

vertical











rondo	 DSN RN-11000-21xx	 DSN RN-22000-21xx	 DSN RN-33000-21xx	 DSN RN-12000-21xx	 DSN RN-13000-21xx	dimensions (h*w) 157*86 mm
quadro	 DSN RQ-11000-21xx	 DSN RQ-22000-21xx	 DSN RQ-33000-21xx	 DSN RQ-12000-21xx	 DSN RQ-13000-21xx	

Other combinations of multiple frames can be custom made.

horizontal | custom made

rondo	 DSN RN-44000-12xx	 DSN RN-14000-12xx	 DSN RN-23000-12xx	 DSN RN-24000-12xx	 DSN RN-34000-12xx	dimensions (h*w) 86*157 mm
quadro	 DSN RQ-44000-12xx	 DSN RQ-14000-12xx	 DSN RQ-23000-12xx	 DSN RQ-24000-12xx	 DSN RQ-34000-12xx	
rondo	 DSN RN-22200-13xx	 DSN RN-44400-13xx	 DSN RN-11200-13xx	 DSN RN-12200-13xx	 DSN RN-11300-13xx	dimensions (h*w) 86*228 mm
quadro	 DSN RQ-22200-13xx	 DSN RQ-44400-13xx	 DSN RQ-11200-13xx	 DSN RQ-12200-13xx	 DSN RQ-11300-13xx	
rondo	 DSN RN-12300-13xx	 DSN RN-22300-13xx	 DSN RN-23300-13xx	 DSN RN-33400-13xx	 DSN RN-34400-13xx	
quadro	 DSN RQ-12300-13xx	 DSN RQ-22300-13xx	 DSN RQ-23300-13xx	 DSN RQ-33400-13xx	 DSN RQ-34400-13xx	
rondo	 DSN RN-11400-13xx	 DSN RN-12400-13xx	 DSN RN-22400-13xx	 DSN RN-14300-13xx	 DSN RN-24300-13xx	
quadro	 DSN RQ-11400-13xx	 DSN RQ-12400-13xx	 DSN RQ-22400-13xx	 DSN RQ-14300-13xx	 DSN RQ-24300-13xx	

vertical | custom made

rondo	 DSN RN-44000-21xx	 DSN RN-14000-21xx	 DSN RN-23000-21xx	 DSN RN-24000-21xx	 DSN RN-34000-21xx	dimensions (h*w) 157*86 mm
quadro	 DSN RQ-44000-21xx	 DSN RQ-14000-21xx	 DSN RQ-23000-21xx	 DSN RQ-24000-21xx	 DSN RQ-34000-21xx	



fittings / sockets



fitting, arrangement 1
single pole switch
10 AX, 250 V AC

DSN 01-00001 single toggle white
DSN 01-00002 single toggle black
DSN 01-00005 single toggle patina

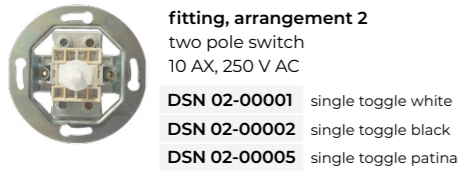

fitting, arrangement 2
two pole switch
10 AX, 250 V AC

DSN 02-00001 single toggle white
DSN 02-00002 single toggle black
DSN 02-00005 single toggle patina

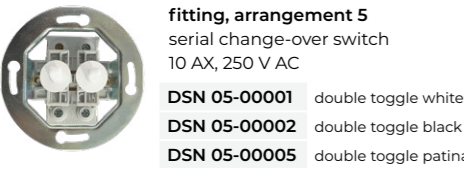

fitting, arrangement 5
serial change-over switch
10 AX, 250 V AC

DSN 05-00001 double toggle white
DSN 05-00002 double toggle black
DSN 05-00005 double toggle patina

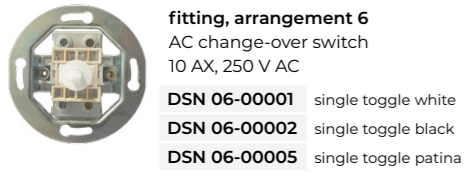

fitting, arrangement 6
AC change-over switch
10 AX, 250 V AC

DSN 06-00001 single toggle white
DSN 06-00002 single toggle black
DSN 06-00005 single toggle patina

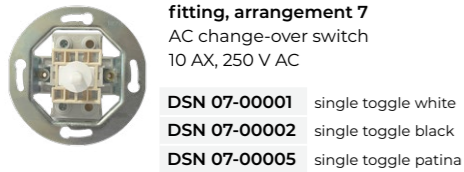

fitting, arrangement 7
AC change-over switch
10 AX, 250 V AC

DSN 07-00001 single toggle white
DSN 07-00002 single toggle black
DSN 07-00005 single toggle patina

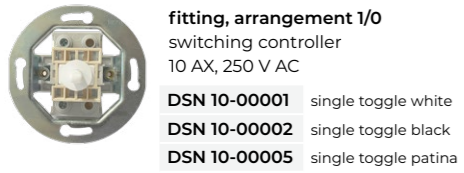

fitting, arrangement 1/0
switching controller
10 AX, 250 V AC

DSN 10-00001 single toggle white
DSN 10-00002 single toggle black
DSN 10-00005 single toggle patina

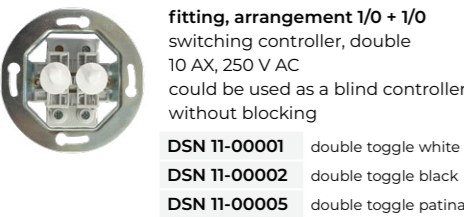

fitting, arrangement 1/0 + 1/0
switching controller, double
10 AX, 250 V AC
could be used as a blind controller
without blocking

DSN 11-00001 double toggle white
DSN 11-00002 double toggle black
DSN 11-00005 double toggle patina

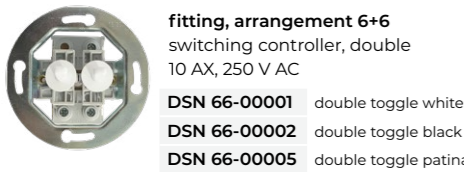

fitting, arrangement 6+6
switching controller, double
10 AX, 250 V AC

DSN 66-00001 double toggle white
DSN 66-00002 double toggle black
DSN 66-00005 double toggle patina

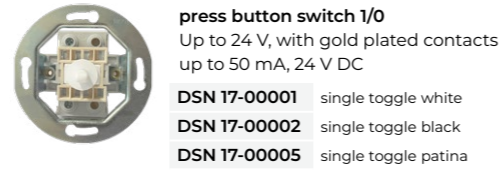

press button switch 1/0
Up to 24 V, with gold plated contacts
up to 50 mA, 24 V DC

DSN 17-00001 single toggle white
DSN 17-00002 single toggle black
DSN 17-00005 single toggle patina

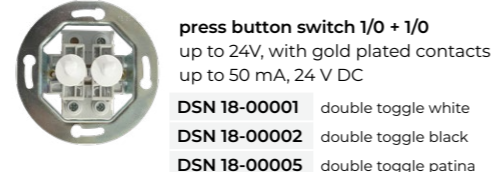

press button switch 1/0 + 1/0
up to 24V, with gold plated contacts
up to 50 mA, 24 V DC

DSN 18-00001 double toggle white
DSN 18-00002 double toggle black
DSN 18-00005 double toggle patina

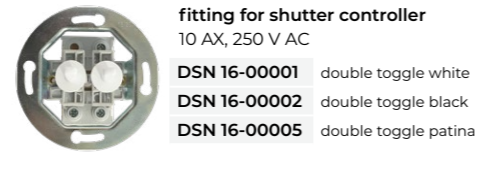

fitting for shutter controller
10 AX, 250 V AC

DSN 16-00001 double toggle white
DSN 16-00002 double toggle black
DSN 16-00005 double toggle patina

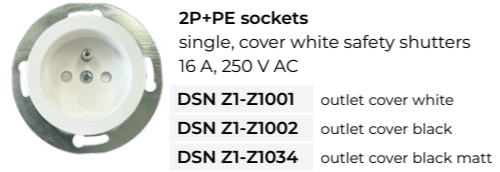

2P+PE sockets
single, cover white safety shutters
16 A, 250 V AC

DSN Z1-Z1001 outlet cover white
DSN Z1-Z1002 outlet cover black
DSN Z1-Z1034 outlet cover black matt

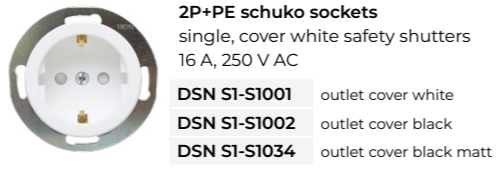

2P+PE schuko sockets
single, cover white safety shutters
16 A, 250 V AC

DSN S1-S1001 outlet cover white
DSN S1-S1002 outlet cover black
DSN S1-S1034 outlet cover black matt

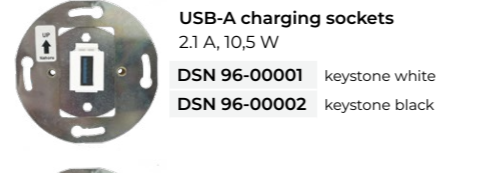

USB-A charging sockets
2.1 A, 10,5 W

DSN 96-00001 keystone white
DSN 96-00002 keystone black



USB-C charging sockets
2.1 A, 10,5 W

DSN 9C-00001 keystone white
DSN 9C-00002 keystone black

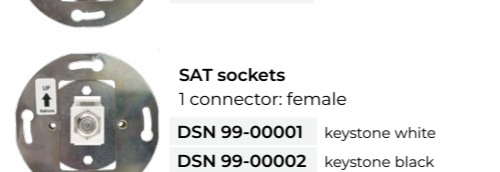

TV sockets
1 connector: IEC female

DSN 97-00001 keystone white
DSN 97-00002 keystone black



SAT sockets
1 connector: female

DSN 99-00001 keystone white
DSN 99-00002 keystone black

fittings / sockets



PC Cat. 5E sockets
1 connector: RJ 45 cat. 5E, UTP

DSN 93-00001 keystone white
DSN 93-00002 keystone black

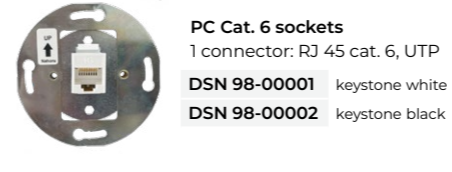

PC Cat. 6 sockets
1 connector: RJ 45 cat. 6, UTP

DSN 98-00001 keystone white
DSN 98-00002 keystone black



socket, british standard 2P + T(E)
single, for a glass frame
13 A, 250 V AC

DSN A1-A0000

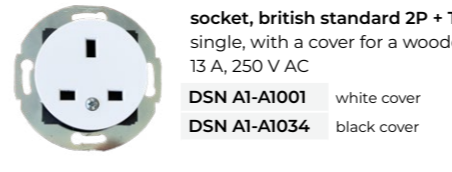

socket, british standard 2P + T(E)
single, with a cover for a wooden frame
13 A, 250 V AC

DSN A1-A1001 white cover
DSN A1-A1034 black cover



support frame for blind cover

DSN 60-00000

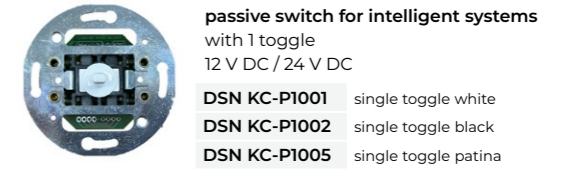

passive switch for intelligent systems
with 1 toggle
12 V DC / 24 V DC

DSN KC-P1001 single toggle white
DSN KC-P1002 single toggle black
DSN KC-P1005 single toggle patina

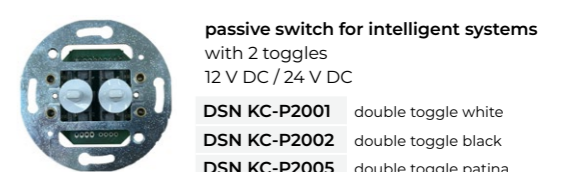

passive switch for intelligent systems
with 2 toggles
12 V DC / 24 V DC

DSN KC-P2001 double toggle white
DSN KC-P2002 double toggle black
DSN KC-P2005 double toggle patina



EBERLE analogue ROOM thermostat
under plaster mounting

DSN 2T-00000



EBERLE analogue FLOOR thermostat
under plaster mounting, with sensor

DSN 3T-00000



EBERLE digital thermostat
universal

DSN 4T-00000

i **Thermostats are available only in the NEXA QUADRO collection.**
When selecting a universal digital thermostat and connecting it as a floor thermostat, it is necessary to purchase the floor sensor DSN 56 separately. More information about thermostats can be found on page 72.



i Toggles are part of switching mechanisms and cannot be ordered separately. The devices are universal for both collections of the NEXA series.



retro

*tradition in
a modern design*



The RETRO range of switches and sockets introduces an original design inspired by rotary ceramic switches from the 1930's and world unique functionalist architecture of Zlin city, where OBZOR comes from. Therefore the RETRO range finds its place not only in rustic, vintage interiors, but also in modern loft, minimalist and industrial interiors.



A few clever interior elements, such as switches and sockets, will enhance the charm of your interior. Our RETRO switch is not just an unobtrusive device that fulfils its essential purpose but is equivalent design companion to the rest of your household equipment.

Let us introduce you to switches that are anything but discreet. No lines, edges or restraint in dimensions. RETRO switches are round, relatively massive and controlled by a rotary handle.

RETRO switches stand out in modern lofts and other minimalist interiors. They will fit well on revealed brick walls, concrete walls as well as on ceramic tiles. RETRO will also add charm to rustic interior, e.g. in rural chalets.

The RETRO line offers a complete range of fittings to meet today's requirements for comfortable living:

- various switching fittings
- shutter controller
- classic sockets (schuko version available)
- computer sockets
- TV sockets
- SAT sockets
- HDMI sockets
- USB charging sockets
- thermostats and motion sensors

There are four collections of noble natural materials to choose from:

- glass
- ceramics
- solid wood

glass collection

Design that is not ostentatious or complicated, but simply great, bringing out the beauty of real glass. Timeless switches from this collection will highlight modern furnished interiors as well as masterpieces of modern architecture.



glass white frame
/ OBZ handle patina



glass black frame
/ BTA handle white



glass white frame
/ sockets cover black matt



DO YOU WANT TO
KNOW MORE?
www.retrovypinac.cz/en





ceramic collection

Ceramic collection combines white and black ceramic frames and covers. In case of switches you can choose from three different types of control handles that will bring up fresh and exciting combinations!



ceramic white frame / cover white
/ OBZ handle patina



ceramic black frame / cover white
/ single toggle black



ceramic black frame / cover black
/ BTA handle white

hand painted collection

The hand painted white ceramic collection offers single frames in four folklore patterns. These can be combined with any of our covers and handles / toggles.



pattern 1 / cover white
/ double toggle white



pattern 2 / cover white
/ ZLN handle patina



pattern 3 / cover white
/ OBZ handle patina



wood collection

In this collection we present solid wood frames where you can choose between light oak, dark stained oak and maple in combination with white or cover black.



wooden maple frame / cover white / BTA handle patina



wooden light oak frame / cover black / single toggle white



wooden dark stained oak frame / cover white / double toggle black

frames

glass



wood **

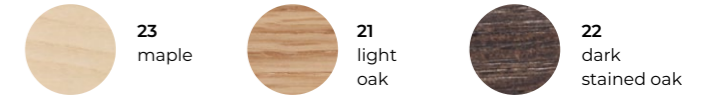

ceramic ***







- * Until stocks are sold out
- ** For wooden frames we use only solid wood therefore each frame is unique and tone/pattern might slightly vary.
- *** The painted RETRO frames are available by order only.



ORDER CODE:
DSR 00-00000-11XX

frame multiplicities

	DSR 00-00000-11XX	dimensions (h*w) 97*97 mm all collections
	DSR 00-00000-12XX	dimensions (h*w) 97*168 mm ceramic (not painted), wood, glass
	DSR 00-00000-13XX	dimensions (h*w) 97*239 mm ceramic (not painted), wood
	DSR 00-00000-14XX	dimensions (h*w) 97*310 mm wood



Fittings and sockets can be combined within up to fourfold frame wall mounted in horizontal or vertical position. Same frame can be used for both options.

sets



switch arrangement
1, 2, 5, 6, 7, 1/0,
shutter switch



switch (glass) arrangement
1, 2, 5, 6, 7, 1/0,
shutter switch



single toggle switch
arrangement 1, 2, 6, 7, 1/0,
press button up to 24 V



double toggle switch
arrangement 5, 6+6, 1/0 + 1/0
shutter switch,
press button up to 24 V



LED dimmer



USB-A sockets
/ USB-A charging sockets



HDMI sockets



USB-C charging sockets



PC sockets
Cat. 5E / Cat. 6



TV sockets



SAT sockets



single sockets



schuko
single sockets



thermostat
(available only in wooden
and glass frames)



motion sensor
(available only in wooden
and glass frames)



single sockets british
standard in a glass and
wooden frame

covers



switch cover white
+ white BTA handle
DSR 00-01201-0000



switch cover black
+ white BTA handle
DSR 00-02201-0000



HDMI, USB, TV, SAT
sockets cover, white
DSR 00-91000-0000



switch cover white
+ black BTA handle
DSR 00-01202-0000



switch cover black
+ black BTA handle
DSR 00-02202-0000



HDMI, USB, TV, SAT
sockets cover, black
DSR 00-92000-0000



switch cover white
+ patina BTA handle
DSR 00-01203-0000



switch cover black
+ patina BTA handle
DSR 00-02203-0000



PC sockets cover,
white
DSR 00-93000-0000



switch cover white
+ patina OBZ handle
DSR 00-01103-0000



switch cover black
+ patina OBZ handle
DSR 00-02103-0000



PC sockets cover,
black
DSR 00-94000-0000



switch cover white
+ patina ZLN handle
DSR 00-01303-0000



switch cover black
+ patina ZLN handle
DSR 00-02303-0000



sockets cover,
white
DSR 00-Z1000-0000



cover for a LED dimmer
rotary button
DSR 00-03401-0000



cover for a LED dimmer
rotary button
DSR 00-03434-0000



sockets cover,
black matt
DSR 00-Z2000-0000



cover for a LED dimmer
rotary button
DSR 00-04401-0000



cover for a LED dimmer rotary
button black/black mat
DSR 00-04434-0000



schuko sockets cover,
white
DSR 00-S3000-0000



blind cover
white
DSR 60-61000-0000



blind cover
black
DSR 60-62000-0000



schuko sockets cover,
black matt
DSR 00-S4000-0000



For RETRO series switches, a long-proven cam switch mechanism is used.











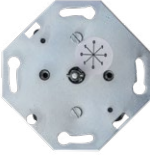
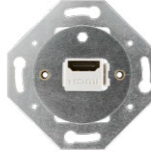

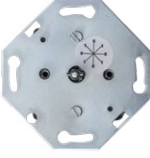
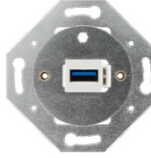

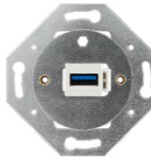

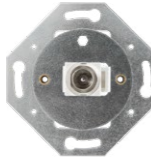

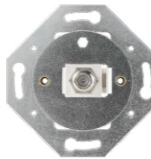
Toggle switches use a rocker mechanism.

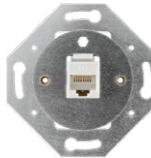

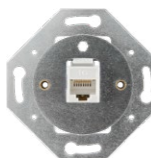

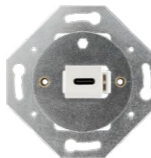







Switch covers and communication sockets cannot be used for RETRO glass collection. You can find covers for RETRO glass on page 37.

fittings / sockets

 fitting, arrangement 1 singlepole switch 16 AX, 250 V AC DSR 01-00000-0000	 HDMI sockets 1 connector: HDMI female DSR 92-00000-0000	 2P+PE sockets single, cover white safety shutters 16 A, 250 V AC DSR Z1-Z1000-0000
 fitting, arrangement 2 twopole switch 16 AX, 250 V AC DSR 02-00000-0000	 USB-A sockets 1 connector: USB 3.0 female DSR 94-00000-0000	 2P+PE sockets single, black matt cover safety shutters 16 A, 250 V AC DSR Z1-Z2000-0000
 fitting, arrangement 5 serial change-over switch 16 AX, 250 V AC DSR 05-00000-0000	 USB-A charging sockets 1 connector: USB 3.0 female + charger (2100 mA) DSR 95-00000-0000	 2P+PE schuko sockets single, cover white safety shutters 16 A, 250 V AC DSR S2-S3000-0000
 fitting, arrangement 6 AC change-over switch 16 AX, 250 V AC DSR 06-00000-0000	 TV sockets 1 connector: IEC female DSR 97-00000-0000	 2P+PE schuko sockets single, black matt cover safety shutters 16 A, 250 V AC DSR S2-S4000-0000
 fitting, arrangement 7 crossbar switch 16 AX, 250 V AC DSR 07-00000-0000	 SAT sockets 1 connector: female DSR 99-00000-0000	 blind cover DSR 00-61000-0000
 fitting, arrangement 1/0 switching controller 16 AX, 250 V AC DSR 10-00000-0000	 PC Cat. 5E sockets 1 connector: RJ45 Cat. 5E UTP DSR 93-00000-0000	 blind cover DSR 00-62000-0000
 fitting for shutter controller rotary 16 AX, 230 V AC DSR 22-00000-0000	 PC Cat. 6 sockets 1 connector: RJ45 Cat. 6 UTP DSR 98-00000-0000	 LED dimmer with arrangement 6 230 V AC, load 0-100 W LED, 10-250 W incandescent light bulb DSR 23-00000-0000
 3 gang 1 way switch 16 AX, 230V AC DSR 03-00000-0000	 USB-C charging sockets 1 connector: USB-C charger 2,1 A, 10,5 W DSR 9C-00000-0000	 socket, british standard 2P + T(E) single 13 A, 250 V AC DSR A1-A1000 white DSR A1-A2000 black

fittings with covers & toggles

 fitting, arrangement 1 single pole switch 10 AX, 250 V AC DPR 01-01001-0000 cover white / single toggle white DPR 01-01002-0000 cover white / single toggle black DPR 01-01003-0000 cover white / single toggle patina DPR 01-02001-0000 cover black / single toggle white DPR 01-02002-0000 cover black / single toggle black DPR 01-02003-0000 cover black / single toggle patina	 press button 1/0, up to 24 V 50mA, 24 V DC DPR 17-01001-0000 cover white / single toggle white DPR 17-01002-0000 cover white / single toggle black DPR 17-01003-0000 cover white / single toggle patina DPR 17-02001-0000 cover black / single toggle white DPR 17-02002-0000 cover black / single toggle black DPR 17-02003-0000 cover black / single toggle patina
 fitting, arrangement 2 two pole switch 10 AX, 250 V AC DPR 02-01001-0000 cover white / single toggle white DPR 02-01002-0000 cover white / single toggle black DPR 02-01003-0000 cover white / single toggle patina DPR 02-02001-0000 cover black / single toggle white DPR 02-02002-0000 cover black / single toggle black DPR 02-02003-0000 cover black / single toggle patina	 fitting, arrangement 1/0 + 1/0 switching controller, double 10AX, 250 V AC DPR 11-03001-0000 cover white / double toggle white DPR 11-03002-0000 cover white / double toggle black DPR 11-03003-0000 cover white / double toggle patina DPR 11-04001-0000 cover black / double toggle white DPR 11-04002-0000 cover black / double toggle black DPR 11-04003-0000 cover black / double toggle patina
 fitting, arrangement 5 serial change-over switch 10 AX, 250 V AC DPR 05-03001-0000 cover white / double toggle white DPR 05-03002-0000 cover white / double toggle black DPR 05-03003-0000 cover white / double toggle patina DPR 05-04001-0000 cover black / double toggle white DPR 05-04002-0000 cover black / double toggle black DPR 05-04003-0000 cover black / double toggle patina	 fitting for shutter controller 10 AX, 250 V AC DPR 16-03001-0000 cover white / double toggle white DPR 16-03002-0000 cover white / double toggle black DPR 16-03003-0000 cover white / double toggle patina DPR 16-04001-0000 cover black / double toggle white DPR 16-04002-0000 cover black / double toggle black DPR 16-04003-0000 cover black / double toggle patina
 fitting, arrangement 6 AC change-over switch 10 AX, 250 V AC DPR 06-01001-0000 cover white / single toggle white DPR 06-01002-0000 cover white / single toggle black DPR 06-01003-0000 cover white / single toggle patina DPR 06-02001-0000 cover black / single toggle white DPR 06-02002-0000 cover black / single toggle black DPR 06-02003-0000 cover black / single toggle patina	 double press button 1/0+1/0, up to 24 V 50mA, 24 V DC DPR 18-03001-0000 cover white / double toggle white DPR 18-03002-0000 cover white / double toggle black DPR 18-03003-0000 cover white / double toggle patina DPR 18-04001-0000 cover black / double toggle white DPR 18-04002-0000 cover black / double toggle black DPR 18-04003-0000 cover black / double toggle patina
 fitting, arrangement 7 crossbar switch 10 AX, 250 V AC DPR 07-01001-0000 cover white / single toggle white DPR 07-01002-0000 cover white / single toggle black DPR 07-01003-0000 cover white / single toggle patina DPR 07-02001-0000 cover black / single toggle white DPR 07-02002-0000 cover black / single toggle black DPR 07-02003-0000 cover black / single toggle patina	 fitting, arrangement 6+6 double AC change-over switch 10 AX, 250 V AC DPR 66-03001-0000 cover white / double toggle white DPR 66-03002-0000 cover white / double toggle black DPR 66-03003-0000 cover white / double toggle patina DPR 66-04001-0000 cover black / double toggle white DPR 66-04002-0000 cover black / double toggle black DPR 66-04003-0000 cover black / double toggle patina
 fitting, arrangement 1/0 switching controller 10 AX, 250 V AC DPR 10-01001-0000 cover white / single toggle white DPR 10-01002-0000 cover white / single toggle black DPR 10-01003-0000 cover white / single toggle patina DPR 10-02001-0000 cover black / single toggle white DPR 10-02002-0000 cover black / single toggle black DPR 10-02003-0000 cover black / single toggle patina	

toggle colors / metal

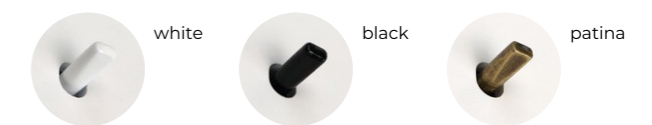

i **IMPORTANT:** Recommended min. depth of installation box for RETRO series is 60 mm. For more information, see the chapter Technical drawings or contact our sales department. Connectors for keystone sockets can also be supplied in black color.

i RETRO toggle switches are suitable for installation into standard installation boxes. For more information, see the chapter Technical drawings or contact our sales department. Toggle is always an integral part of the fitting and the cover is supplied with the device. Not for sale separately.

thermostats and motion sensors



EBERLE analogue ROOM thermostat under plaster mounting

- DSR 2T-00000-1130 white glass
- DSR 2T-00000-1131 black glass
- DSR 2T-00000-1121 light oak
- DSR 2T-00000-1122 dark stained oak
- DSR 2T-00000-1123 maple



EBERLE analogue FLOOR thermostat under plaster mounting, with sensor

- DSR 3T-00000-1130 white glass
- DSR 3T-00000-1131 black glass
- DSR 3T-00000-1121 light oak
- DSR 3T-00000-1122 dark stained oak
- DSR 3T-00000-1123 maple



digital thermostat EBERLE universal

- DSR 4T-00000-1130 white glass
- DSR 4T-00000-1131 black glass
- DSR 4T-00000-1121 light oak
- DSR 4T-00000-1122 dark stained oak
- DSR 4T-00000-1123 maple



move sensor B.E.G

- DSR BX-00000-1130 white glass
- DSR BX-00000-1131 black glass
- DSR BX-00000-1121 light oak
- DSR BX-00000-1122 dark stained oak
- DSR BX-00000-1123 maple

i For floor connection with our digital thermostat you need to add extra DSR 56 floor sensor.

i For more thermostat info go to page 72. Thermostats are available assembled with frames only.

i For more motion sensor info go to page 73, X = chosen motion sensor type. Available assembled with frame only.



glass collection



BTA handle white + frame

- DSR XX-00201-1130 white
- DSR XX-00201-1131 black *



BTA handle black + frame

- DSR XX-00202-1130 white
- DSR XX-00202-1131 black *



OBZ handle patina + frame

- DSR XX-00103-1130 white



single sockets

- DSR Z1-Z1000-Z130 white, white cover
- DSR Z1-Z1000-Z131 black *, white cover
- DSR Z1-Z2000-Z130 white, black cover
- DSR Z1-Z2000-Z131 black *, black cover



schuko single sockets

- DSR S2-S3000-Z130 white, white cover
- DSR S2-S3000-Z131 black *, white cover
- DSR S2-S4000-Z130 white, black cover
- DSR S2-S4000-Z131 black *, black cover



HDMI sockets

- DSR 92-00000-U130 white
- DSR 92-00000-U131 black *



PC sockets

- DSR 93-00000-P130 Cat. 5E / white
- DSR 93-00000-P131 Cat.. 5E / black *
- DSR 98-00000-P130 Cat. 6 / white *
- DSR 98-00000-P131 Cat. / black *



USB-A sockets

- DSR 94-00000-U130 white
- DSR 94-00000-U131 black *



USB-A charging sockets

- DSR 95-00000-U130 white
- DSR 95-00000-U131 black *



USB-C charging sockets

- DSR 9C-00000-U130 white
- DSR 9C-00000-U131 black *



TV sockets

- DSR 97-00000-U130 white
- DSR 97-00000-U131 black *



SAT sockets

- DSR 99-00000-U130 white
- DSR 99-00000-U131 black *



EBERLE analogue ROOM thermostat under plaster mounting

- DSR 2T-00000-1130 white
- DSR 2T-00000-1131 black *



EBERLE analogue FLOOR thermostat under plaster mounting, with sensor

- DSR 3T-00000-1130 white
- DSR 3T-00000-1131 black *



digital thermostat EBERLE universal

- DSR 4T-00000-1130 white
- DSR 4T-00000-1131 black *



move sensor B.E.G

- DSR BX-00000-1130 white
- DSR BX-00000-1131 black *

i Glass collection offers white and black frame colours together with BTA white/black and OBZ patina handles.



i DSR Z1 / DSR S2 sockets include safety shutters. Connectors for keystone sockets can also be supplied in black color.
* Until stocks are sold out



decente

pure lines

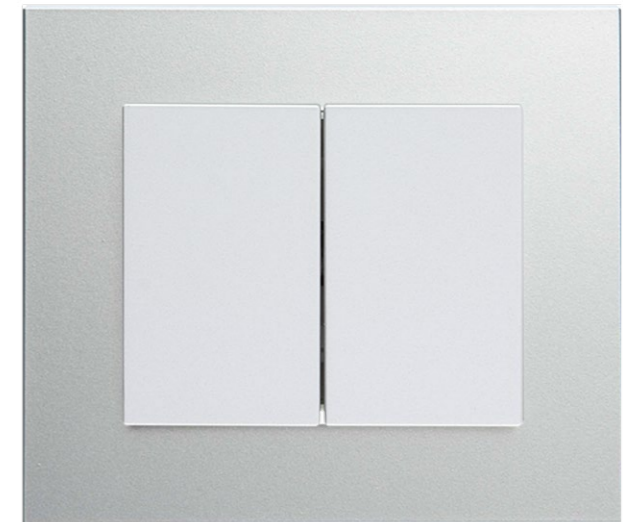

Clean lines and timeless design, together with noble natural materials, characterize the DECENTE series. Wider, luxurious looking glass, wooden, metal or plexi-glass frames beautifully complement a variety of modern interior styles. Frames of minimal thickness provide an elegant feel. Covers are made of high quality, UV-stable plastic.



timeless design

Various materials in different shades of glass, wood, metal, and plexiglass allow perfect coordination with the interior according to your preferences.



wooden walnut MDF frame
/ cover white



wooden mahogany MDF frame
/ cover titanium



wooden oak MDF frame
/ cover white



glass milk white frame
/ cover white



stainless steel frame
/ cover black matt

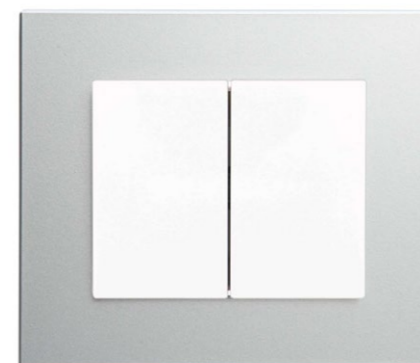

aluminium frame
/ cover white









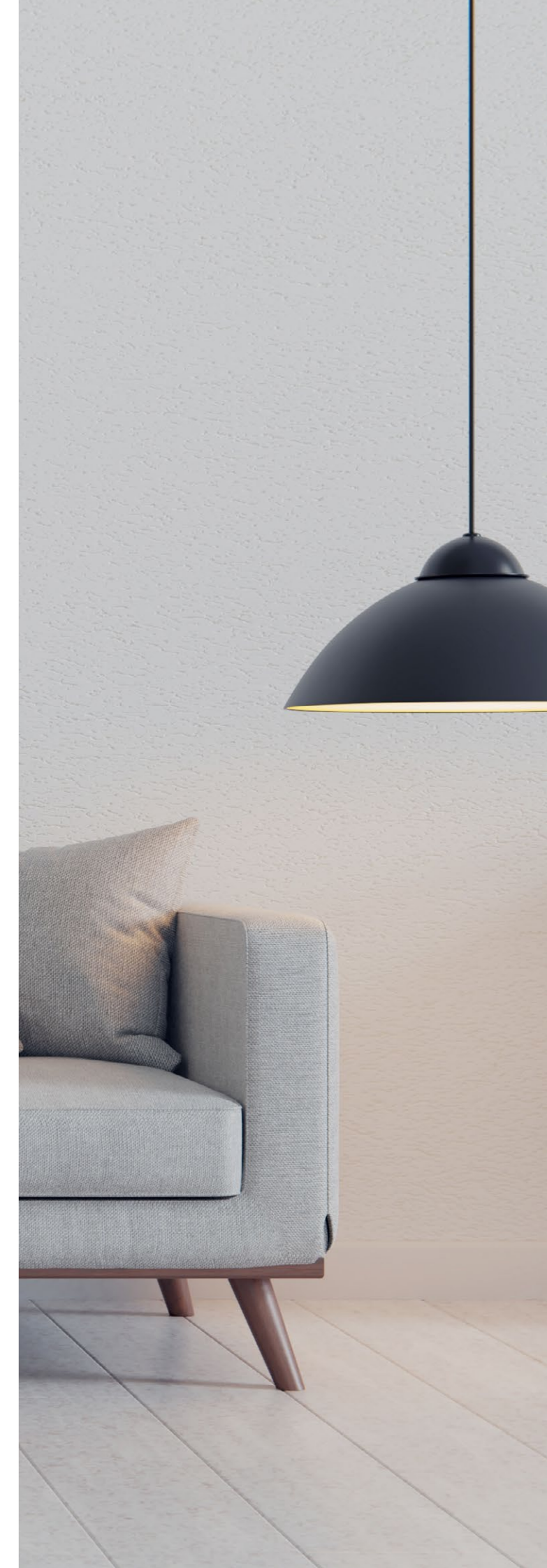

plexiglass black frame
/ cover white



Try our online designer tool
www.domovnivypinace.cz/en











frame multiplicities decente

	DSD 00-00000- 11XX	dimensions (h×w) 95×110 mm
	DSD 00-00000- 12XX	dimensions (h×w) 95×181 mm
	DSD 00-00000- 13XX	dimensions (h×w) 95×252 mm
	DSD 00-00000- 14XX	dimensions (h×w) 95×323 mm
	DSD 00-00000- 21XX	dimensions (h×w) 166×110 mm
	DSD 00-00000- 31XX	dimensions (h×w) 237×110 mm
	DSD 00-00000- 41XX	dimensions (h×w) 308×110 mm
	DSD 00-00000- 82XX	dimensions (h×w) 130×110 mm

i Please note that horizontal and vertical multiple frames have different design.

decente mini

	DSI 00-00000- 118X	dimensions (h×w) 90×102 mm
	DSI 00-00000- 128X	dimensions (h×w) 90×174 mm
	DSI 00-00000- 138X	dimensions (h×w) 90×245 mm
	DSI 00-00000- 148X	dimensions (h×w) 90×316 mm
	DSI 00-00000- 218X	dimensions (h×w) 162×102 mm
	DSI 00-00000- 318X	dimensions (h×w) 233×102 mm
	DSI 00-00000- 418X	dimensions (h×w) 304×102 mm
	DSI 00-00000- 828X	dimensions (h×w) 125×102 mm

i Decente mini is offered only in plexi and plexiglass.

sets

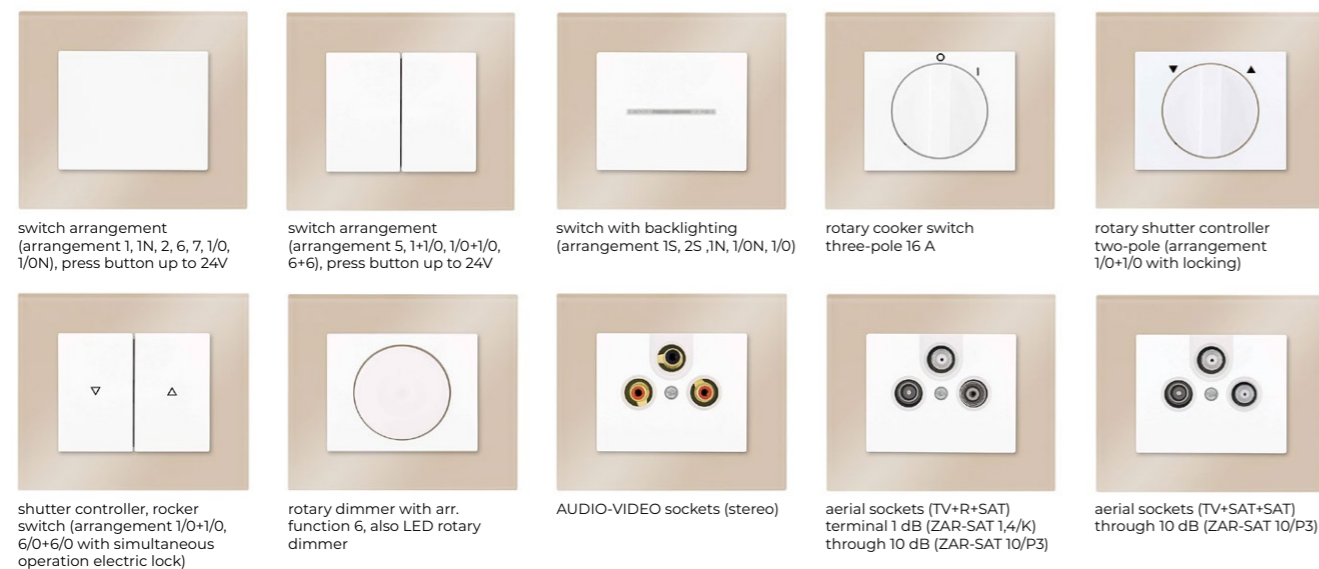

sets

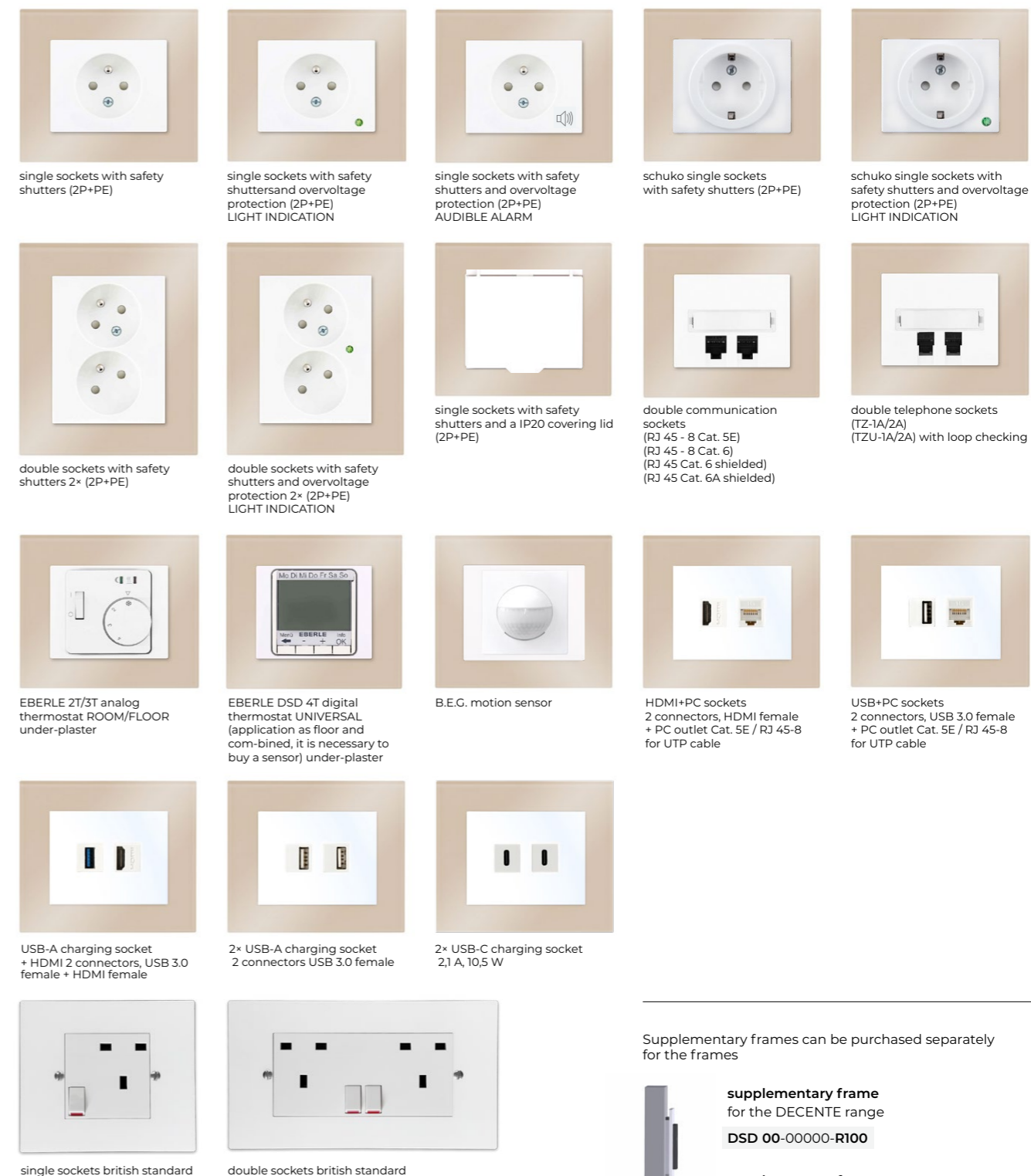

i Connectors for keystone sockets can also be supplied in black colour.

Supplementary frames can be purchased separately for the frames

-  **supplementary frame** for the DECENTE range
DSD 00-00000-R100
-  **supplementary frame** for the DECENTE Mini range
DSI 00-00000-R100

i Supplementary frames are installed between the switch frame and the wall and are intended for DECENTE and DECENTE Mini frames.

frames

glass

57 snow white (RAL 9003)	50 milk white (RAL 9010)	52 dove grey (RAL 7035)	59 cream white (RAL 1013)
5A mocca (REF 1236)	5F white matt (REF 9003)	5G bronze matt	5E metal grey matt (RAL 9006)
58 anthracite black (RAL 9005)	5K black matt (REF 9005)	5H* mirror bronze	5J mirror steel
5C* indigo (REF 0627)	53* ice green (RAL 6019)	55* palm green (RAL 1060)	51* brick orange (RAL 2001)
54* cherry red (RAL 3001)	56* chocolate brown (RAL 8017)		

wood **

60 MDF oak **	61 MDF walnut **	62* MDF mahogany **
-------------------------	----------------------------	-------------------------------

metal

70 aluminium	71 stainless steel
------------------------	------------------------------

plexi

80 white (RAL 9003)	81 black (RAL 9005)
----------------------------------	----------------------------------

plexiglass

82 white (RAL 9003)	83 black (RAL 9005)	84 grey (RAL 9006)
----------------------------------	----------------------------------	---------------------------------

covers

single cover for switches: 1, 2, 6, 7, 1/0, 1/0N DSD 00-010YY-0000	cover for a shutter controller with rotary controller DSD 00-216YY-0000	cover for a cooker switch with rotary controller DSD 00-215YY-0000
single cover with backlighting DSD 00-030YY-0000	double cover for shutter controller DSD 00-026YY-0000	cover for a dimmer DSD 00-270XX-0000
double cover for switches: 5, 6+6, 1/0+1/0, 1/0+1 DSD 00-020YY-0000	single sockets cover with safety shutters and IP20 covering lid, 2P+PE DSD 00-870YY-0000	cover for a LED dimmer DSD 00-230XX-0000
cover for a single sockets with safety shutters 2P+PE DSD 00-810YY-0000	schuko sockets cover, single with safety shutters and IP20 covering lid, 2P+PE DSD 00-880YY-0000	blind cover DSD 00-050YY-0000
cover for a single sockets with safety shutters and overvoltage protection 2P+PE DSD 00-840YY-0000	sockets cover for TV+R+SAT TV+SAT+SAT AUDIO-VIDEO DSD 00-970YY-0000	cover for telephone sockets, double DSD 00-910YY-0000
schuko sockets cover, single with safety shutters 2P+PE DSD 00-830YY-0000	cover for a double sockets with safety shutters 2x (2P+PE) DSD 00-820YY-0000	cover for a double communication sockets DSD 00-930YY-0000
schuko sockets cover, single with safety shutters and overvoltage protection 2P+PE DSD 00-860YY-0000	cover for a double sockets with safety shutters and overvoltage protection 2x (2P+PE) DSD 00-850YY-0000	sockets cover HDMI, PC, USB, USB-C DSD 00-920YY-0000
single cover for passive switch for home automation DSD 00-K100X-0000	double cover for passive switch for home automation DSD 00-K200X-0000	

cover colours

01 snow white glossy	35 white matt	30 aluminium	32 gold
02 anthracite black glossy	34 black matt	31 graphite	33 titanium



* Until stocks are sold out
** Please note that due to uniqueness of natural wooden materials used for DECENTE frames, these may not always be the same, their colour tone and pattern may vary. Colour tones may differ slightly from reality.



ORDER CODE:
DSD 00-00000-XXXX



















ORDER CODE:
DSD 00-000YY-0000

fittings









-  **fitting, arrangement 1**
singlepole switch
10 AX, 250 V AC
DSD 01-00000-0000
-  **fitting, arrangement 1N**
singlepole switch with a zero terminal
10 AX, 250 V AC
DSD 12-00000-0000
-  **fitting, arrangement 2**
twopole switch
10 AX, 250 V AC
DSD 02-00000-0000
-  **fitting, arrangement 5**
serial change-over switch
10 AX, 250 V AC
DSD 05-00000-0000
-  **fitting, arrangement 6**
ac change-over switch
10 AX, 250 V AC
DSD 06-00000-0000
-  **fitting, arrangement 6+6 (6+1)**
ac change-over switch,
double 10 AX, 250 V AC
DSD 66-00000-0000
-  **fitting, arrangement 7**
crossbar switch
10 AX, 250 V AC
DSD 07-00000-0000
-  **fitting, arrangement 1/0**
switching controller
10 AX, 250 V AC
DSD 10-00000-0000
-  **fitting, arrangement 1/0+1/0**
switching controller, double
10 AX, 250 V AC
also suitable as shutter switch without locking
DSD 11-00000-0000
-  **fitting, arrangement 1/0N**
switching controller with a zero terminal
10 AX, 250 V AC
DSD 13-00000-0000
-  **fitting, arrangement 1/0+1**
switching controller
+ singlepole switch
10 AX, 250 V AC
DSD 14-00000-0000
-  **fitting, arrangement 6/0+6/0**
shutter switch with locking
10 AX, 250 V AC
DSD 16-00000-0000

- fitting, arrangement 1+1**
singlepole switch
+ singlepole switch
10 AX, 250 V AC
DSD 15-00000-0000

-  **fitting, arrangement 1/0,
press button, up to 24 V**
50 mA, 24 V DC
DSD 17-00000-0000
-  **fitting, arrangement 1/0 + 1/0,
press button, up to 24 V**
50 mA, 24 V DC
DSD 18-00000-0000
-  **passive switch**
for intelligent systems
50 mA, 12 V DC
DSD KC-00000-0000
-  **passive switch**
for intelligent systems
with KNX module
21-30 V DC
DSD KX-00000-0000
-  **AUDIO-VIDEO sockets**
stereo (2+1)
DSD 72-00000-0000
-  **fitting for cooker switch, rotary**
threepole
16 A, 400 V AC
recommended min. depth of installation box - 60 mm
DSD 21-00000-0000
-  **fitting for shutter controller**
rotary (with locking)
10 A, 230 V AC
recommended min. depth of installation box - 60 mm
DSD 22-00000-0000
-  **dimmer fitting with
arrangement 6**
230 V AC, load
40-250 W
DSD 27-00000-0000
-  **LED dimmer fitting**
230 V AC, load 0-100 W LED,
10-250 W incandescent
light bulb
DSD 23-00000-0000
-  **telephone sockets**
double
TZ-1A2A, TZU
DSD 91-00000-0000
-  **communication sockets**
Cat. 5E / Cat. 6, double
PC outlet, black connectors
2x RJ 45-8 for UTP cable
DSD 93-00000-0000 Cat. 5
DSD 98-00000-0000 Cat. 6
-  **communication sockets**
Cat. 6 / Cat. 6A, double
PC outlet, black connectors
2x RJ 45 shielded for STP cable
DSD 74-00000-0000 Cat. 6
DSD 75-00000-0000 Cat. 6A
-  **HDMI+PC socket**
2 connectors: HDMI female
+ PC outlet Cat. 5E for utp cable
DSD 92-00000-0000
-  **USB-A+PC socket**
2 connectors: USB 3.0 female
+ PC outlet Cat. 5E for utp cable
DSD 94-00000-0000

-  **USB-A charging socket+ HDMI**
2 connectors: USB 3.0 female
+ HDMI female, white connectors
(1000 mA)
DSD 95-00000-0000
-  **2x USB-A charging socket**
2 connectors: USB 3.0 female 2
connectors, 5 V DC / 1000 mA
DSD 96-00000-0000
-  **2x USB-C charging socket**
2 connectors: USB-C charger 2,1
A, 10,5 W
DSD 9C-00000-0000
-  **support frame for HDMI,
USB-A, USB-C, PC connectors**
DSD 35-00000-0000
-  **sockets TV+R+SAT**
terminal, attenuation 1 dB, 300 mA, 24 V DC
for coaxial cables of diameter 4.5-8.3 mm
type designation on the product: ZAR-SAT 1.4/K
DSD 97-00000-0000
-  **sockets TV+R+SAT**
through, attenuation 10 dB, 300 mA, 24 V DC
for coaxial cables of diameter 4.5-8.3 mm
type designation on the product: ZAR-SAT 10/P3
DSD 99-00000-0000
-  **sockets TV+SAT+SAT**
through, attenuation 10 dB, 300 mA, 24 V DC
for coaxial cables of diameter 4.5-8.3 mm
type designation on the product: ZAR-SAT 10/P3
DSD 76-00000-0000
-  **sockets 2P+PE**
single socket with safety shutters and IP 20
covering lid, plastic base 16 A, 250 V AC
DSD 89-870YY-0000
-  **2P+PE sockets**
single, with safety shutters, plastic base
16 A, 250 V AC
DSD 89-810YY-0000
-  **2P+PE with OP sockets**
single, with safety shutters and overvoltage
protection (LIGHT INDICATION)
16 A, 250 V AC
DSD 84-840YY-0000
-  **2P+PE with OP sockets**
single, with safety shutters and overvoltage
protection (AUDIBLE ALARM)
16 A, 250 V AC
DSD 80-810YY-0000
-  **2P+PE schuko sockets**
single, with safety shutters
16 A, 250 V AC
DSD S2-830YY-0000
-  **2P+PE with OP schuko sockets**
single, with safety shutters and overvoltage
protection (LIGHT INDICATION)
16 A, 250 V AC
DSD S3-860YY-0000
-  **2x (2P+PE) sockets**
double, with safety shutters
16 A, 250 V AC
DSD 82-820YY-0000
-  **2x (2P+PE) OP sockets**
double, with safety shutters and with
overvoltage protection (LIGHT INDICATION)
16 A, 250 V AC I max 4.5 kA, Up < 1.2 kV
DSD 85-850YY-0000
-  **sockets schuko 2P+PE**
single socket with safety shutters and IP 20
covering lid, plastic base 16 A, 250 V AC
DSD S2-880YY-0000

sockets cover colours

- | | | | | | | | |
|---|---|---|-------------------------|---|------------------------|---|-----------------------|
|  | 01
snow white
glossy |  | 35
white matt |  | 30
aluminium |  | 32
gold |
|  | 02
anthracite black
glossy |  | 34
black matt |  | 31
graphite |  | 33
titanium |

i Power sockets always come in set with a cover of your choice.
Any connector from the accessories on page 76 can be selected for the support frame.

decente

hotel systems

*comfortable for guests, simple
and effective for staff*

The ACS-line Reception Hotel System by Estelar Company is designed to secure all activities related to running a hotel or pension. The system includes wall-mounted card readers and energy savers in Decente design available in all standard colours and materials which can match other switches and sockets in Decente design. One hotel card will allow room access, lift control, access to authorized areas (parking, wellness, etc.), payments in hotel bars and restaurants, use of other services (bike rental, ski passes, etc.).



ESTELAR
ELEKTRONICKE SYSTÉMY

card reader

Card reader (built-in card scanner) is a device for reading cards and controlling individual access according to permission. Typical use is e.g. opening of hotel entrance door, hotel room access, opening of wellness door within allowed time.

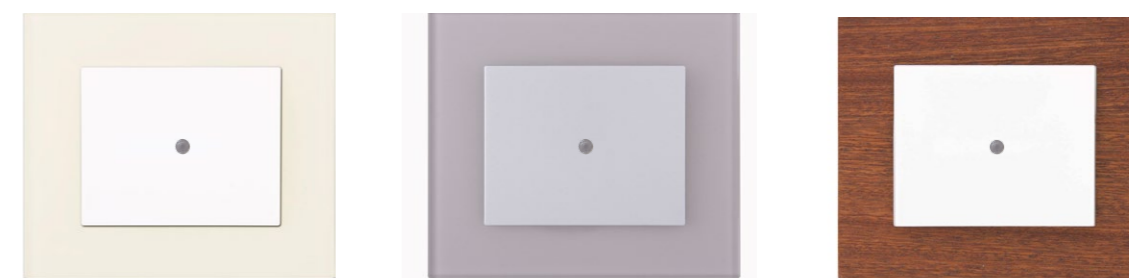

ORDER CODE:
DSD 00-CK0YY-H1XX

energy saver

The Energy Saver is a device that activates a function when a card is inserted and maintains it while the card remains inside. The device is equipped with a card reader and responds only to authorized cards, so it is not possible to replace the card with for example sturdy paper. Typical use is in hotel rooms, where wiring is active only in the presence of a guest, or for light control in meeting rooms, depending on occupancy. Connection of heating sensors for controlling room temperature is also available.



The producer of hotel card readers and hotel systems is ESTELAR, s. r. o.
More info to be found at www.acsline.cz.



Card readers are offered in DECENTE design with white, black or metallic cover.
Frame can be chosen from glass, wood, metal, plexi or plexiglass collection.



ORDER CODE:
DSD 00-HK0YY-H1XX



elegant

*conventional shape,
rounded lines*



A classic, unobtrusively elegant design with rounded lines and dozens of colours to choose from will create a harmonious relationship with any type of interior. Both frame and cover are made of high quality plastic. Soft pastel tones will gently bring up the atmosphere of your interior, while rich and colourful on the contrary will play the role of strong accent that draw attention to detail – the switch itself. We also offer our best-selling metallic colours: aluminium, graphite, gold and titanium.

custom switches

Our unique design allows you to combine any two colours within the frame. Your switch can then look maybe like

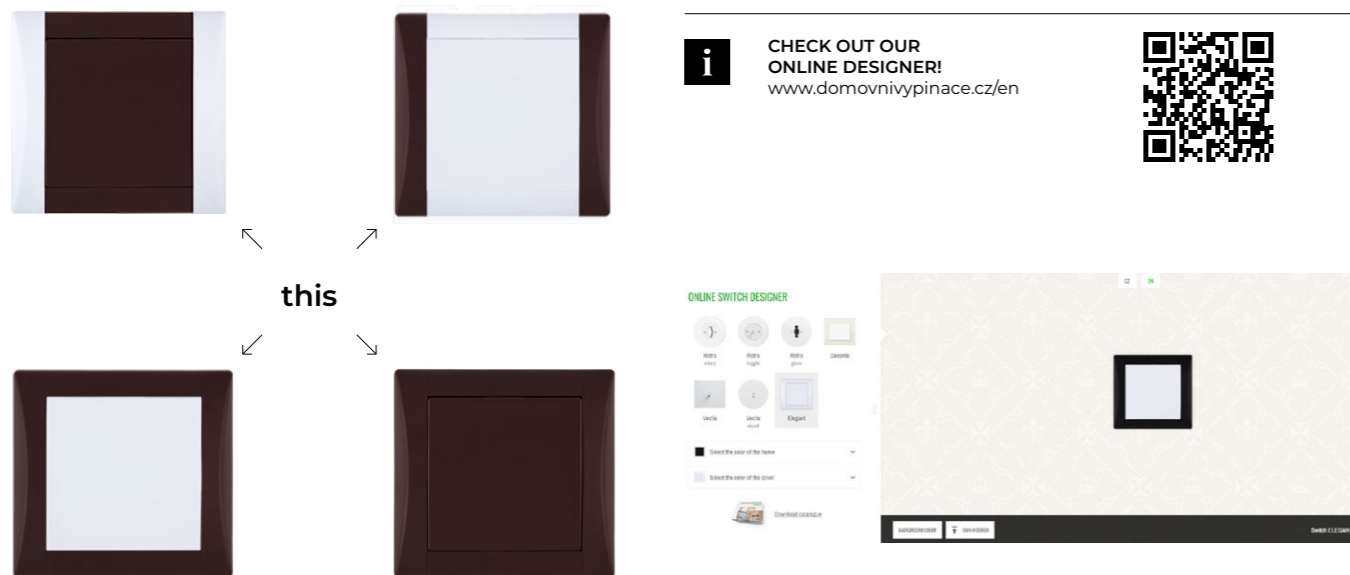

i Frames can be combined with covers of any colour. Unique frame design also allows a combination of base and side segments using any combination of two colours. We are always happy to advise you on the selection.

complex wiring solution in elegant design

The unusual design of the frame connection makes possible to create: up to seven horizontal or triple vertical combinations modul combinations up to 2x5 positions.

the product line includes

- switches, sockets, controllers
- ELEGANT Aqua (IP 44)
- ELEGANT Medical
- vacuum sockets
- thermostats
- motion sensors

for your cosy interior

Do you prefer a modern, but also cosy interior where you could use curtains, carpets and other decorations, that reflect your personal taste? Gentle tones of grey, beige and brown switches would fit right in. These colours are timeless and will give you freedom for further creativity when adding accessories to your interior.



cappuccino frame / cover cappuccino



steel grey frame / cover steel grey



titanium frame / outlet cover titanium grey



sets

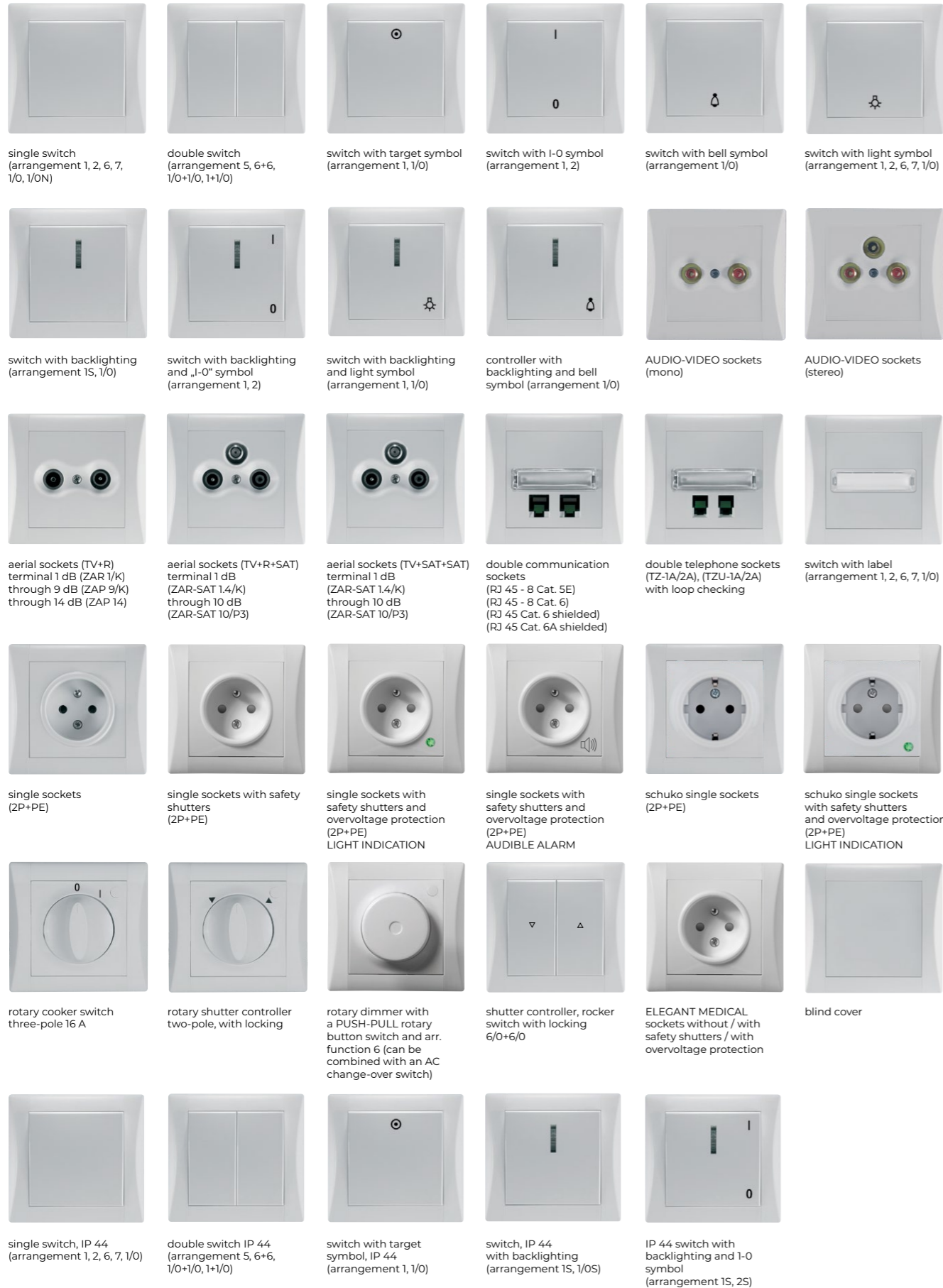

i Slightly rotated sockets cavities allow comfortable plugging in of two devices.

















frames

	01 snow white		06* peach orange		18 cappuccino		30 aluminium
	02 anthracite black		08* ice green		19 steel grey		31 graphite
	03 smoke grey		09* sunflower yellow		20* olive grey		32 gold
	04* vanilla yellow		10 signal brown		21 nut brown		33 titanium
	05 sandy beige		11* ruby red				

i * Until stocks are sold out. Colour tones may differ slightly from reality.

frame multiplicities

	DSE 00-00000-11XXXX	dimensions (h*w) 84*89 mm		DSE 00-00000-21XXXX	dimensions (h*w) 155*89 mm
	DSE 00-00000-82XXXX	double outlet frame dimensions (h*w) 115*89 mm		DSE 00-00000-31XXXX	dimensions (h*w) 226*89 mm
	DSE 00-00000-12XXXX	dimensions (h*w) 84*160 mm		DSE 00-00000-22XXXX	dimensions (h*w) 155*160 mm
	DSE 00-00000-13XXXX	dimensions (h*w) 84*231 mm		DSE 00-00000-23XXXX	dimensions (h*w) 155*231 mm
	DSE 00-00000-14XXXX	dimensions (h*w) 84*302 mm		DSE 00-00000-24XXXX	dimensions (h*w) 155*302 mm
	DSE 00-00000-15XXXX	dimensions (h*w) 84*373 mm		DSE 00-00000-25XXXX	dimensions (h*w) 155*373 mm
	DSE 00-00000-16XXXX	dimensions (h*w) 84*444 mm			
	DSE 00-00000-17XXXX	dimensions (h*w) 84*515 mm			

i Please note that horizontal and vertical multiple frames have different design.

i ORDER CODE:
DSE 00-00000-XXXXXX

covers

- 

single cover
for switches:
1, 2, 6, 7, 1/0, 1/0N, 1N
DSE 00-010YY-000000
- 

single cover with backlighting with 0-1 symbol
for switches fitted with glow-lamp: 1, 1N, 2, 1/0, 1/0N
DSE 00-031YY-000000
- 

double cover
for switches:
5, 6+6, 1/0+1/0, 1/0+1
DSE 00-020YY-000000
- 

single cover with 0-1 symbol
for switches:
1, 2, 6, 7, 1/0
DSE 00-011YY-000000
- 

single cover with a labeling field
DSE 00-040YY-000000
- 

cover for shutter controller with rotary controller
DSE 00-216YY-000000
- 

single cover with target symbol
for switches: 1, 1/0
DSE 00-012YY-000000
- 

cover for a single sockets without safety shutters 2P+PE
DSE 00-810YY-000000
- 

cover for cooker switch with rotary controller
DSE 00-215YY-000000
- 

single cover with the bell symbol
for switches: 1/0
DSE 00-013YY-000000
- 

cover for a single sockets with safety shutters and overvoltage protection 2P+PE
DSE 00-840YY-000000
- 

double cover for shutter controller
DSE 00-026YY-000000
- 

cover for a dimmer / cover for LED dimmer
DSE 00-270YY-000000
DSE 00-230YY-000000
- 

schuko sockets cover ** with safety shutters 2P+PE
DSE 00-830YY-000000
- 

sockets cover double 2x (2P+PE)
DSE 00-820YY-000000
- 

blind cover
DSE 00-050YY-000000
- 

schuko sockets cover ** with safety shutters and overvoltage protection 2P+PE
DSE 00-860YY-000000
- 

cover for a double sockets with safety shutters 2x (2P+PE)
DSE 00-870YY-000000
- 

cover for a telephone outlet, double
DSE 00-910YY-000000
- 

sockets cover TV+R / AUDIO-VIDEO mono
DSE 00-940YY-000000
- 

cover for a double sockets with safety shutters and overvoltage protection 2x (2P+PE)
DSE 00-850YY-000000
- 

cover for a double communication outlet
DSE 00-930YY-000000
- 

sockets cover TV+R+SAT (TV+SAT+SAT) AUDIO-VIDEO stereo
DSE 00-970YY-000000
- 

single cover with backlighting for switches fitted with glow-lamp: 1, 1N, 2, 1/0, 1/0N
DSE 00-030YY-000000
- 

single cover with backlighting with light symbol for switches fitted with glow-lamp: 1, 1N, 2, 1/0, 1/0N
DSE 00-034YY-000000
- 

single cover with light symbol for switches: 1, 2, 6, 7, 1/0
DSE 00-014YY-000000
- 

single cover with backlighting with bell symbol for switches fitted with glow-lamp: 1/0, 1/0N
DSE 00-033YY-000000

i ORDER CODE:
DSE 00-YYYYY-000000

cover colours

- 

57 snow white
- 

06* peach orange
- 

18 cappuccino
- 

30 aluminium
- 

02 anthracite black
- 

08* ice green
- 

19 steel grey
- 

31 graphite
- 

03 smoke grey
- 

09* sunflower yellow
- 

20* olive grey
- 

32 gold
- 

04* vanilla yellow
- 

10 signal brown
- 

21 nut brown
- 

33 titanium
- 

05 sandy beige
- 

11* ruby red

i * Until stocks are sold out.
Colour tones may differ slightly from reality.

elegant aqua IP 44 covers

- 

single cover IP 44
for switches: 1, 2, 6, 7, 1/0
DSE 00-510YY-000000
- 

single cover IP 44 with target symbol
for switches: 1, 1/0
DSE 00-512YY-000000
- 

single cover IP 44 with backlighting
for switches fitted with a glow-lamp:
1, 1N, 2, 1/0, 1/0N
DSE 00-540YY-000000
- 

IP 44 single sockets cover with a lid and safety shutters 2P+PE
Available colours only 01, 30, 31, 32, 33.
The IP44 outlet is always supplied with a transparent (milk white) lid.
DSE 00-530YY-000000
- 

double cover IP 44
for switches: 5, 6+6, 1/0+1/0, 1/0+1
DSE 00-520YY-000000
- 

IP 44 schuko sockets cover with a lid and safety shutters 2P+PE
Available colours only 01, 30, 31, 32, 33.
The IP44 outlet is always supplied with a transparent (milk white) lid.
DSE 00-530YY-000000
- 







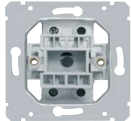
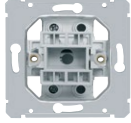
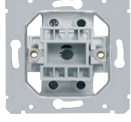
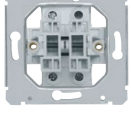
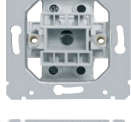
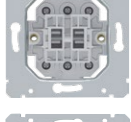
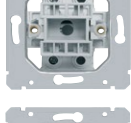
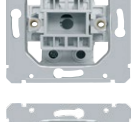
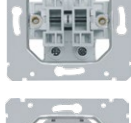
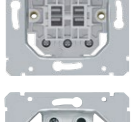
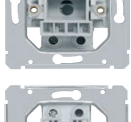
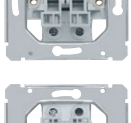
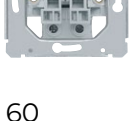

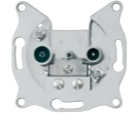

single cover IP 44 with backlighting and 0-1
for switches fitted with a glow-lamp:
1, 1N, 2, 1/0, 1/0N
DSE 00-541YY-000000



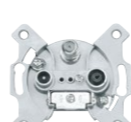
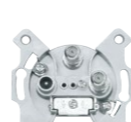



i For ELEGANT AQUA cover colours go to page 63.

fittings



-  **fitting, arrangement 1**
singlepole switch
10 AX, 250 V AC
DSE 01-00000-000000
-  **fitting, arrangement 12**
in singlepole switch
with zero terminal
10 AX, 250 V AC
DSE 12-00000-000000
-  **fitting, arrangement 2**
twopole switch
10 AX, 250 V AC
DSE 02-00000-000000
-  **fitting, arrangement 5**
serial change-over switch
10 AX, 250 V AC
DSE 05-00000-000000
-  **fitting, arrangement 6**
AC change-over switch
10 AX, 250 V AC
DSE 06-00000-000000
-  **fitting, arrangement 6+6 (6+1)**
AC change-over switch, double
10 AX, 250 V AC
DSE 66-00000-000000
-  **fitting, arrangement 7**
crossbar switch
10 AX, 250 V A
DSE 07-00000-000000
-  **fitting, arrangement 1/0**
switching controller
10 AX, 250 V AC
DSE 10-00000-000000
-  **fitting, arrangement 1/0+1/0**
double switching controller
10 AX, 250 V AC
Ize použít jako žaluziový ovladač bez blokace
DSE 11-00000-000000
-  **fitting, arrangement 6/0+6/0**
shutter switch with locking
10 AX, 250 V AC
DSE 16-00000-000000
-  **fitting, arrangement 1**
ON switching controller with zero terminal
10 AX, 250 V AC
DSE 13-00000-000000
-  **fitting, arrangement 1/0+1**
switching controller + singlepole switch
10 AX, 250 V AC
DSE 14-00000-000000
-  **fitting, arrangement 1+1**
singlepole switch + singlepole switch
10 AX, 250 V AC
DSE 15-00000-000000

-  **fitting, arrangement 1/0 +1/0,**
press button, up to 24 V
50 mA, 24 V DC
DSE 17-00000-000000
-  **fitting, arrangement 1/0,**
press button, up to 24 V
50 mA, 24 V DC
DSE 18-00000-000000
-  **fitting for cooker switch, rotary**
threepole
16 A, 400 V AC
DSE 21-00000-000000
-  **fitting for shutter controller, rotary**
(with locking)
10 A, 230 V AC
DSE 22-00000-000000
-  **fitting for rotary dimmer**
with arrangement 6
230 V AC,
load 40–250 W
DSE 27-00000-000000
-  **fitting for LED dimmer**
230 V AC, load
0–100 W LED, 10–250 W
incandescent light bulb
DSE 23-00000-000000
-  **telephone sockets double**
TZ-1A2A
connectors black
DSE 91-00000-000000
-  **telephone sockets double,**
with loop checking
TZU-1A2A
connectors black
DSE 92-00000-000000
-  **communication sockets Cat. 5E double**
2× RJ 45 Cat. 5E
for UTP cable
connectors black
DSE 93-00000-000000
-  **communication sockets Cat. 6 double**
2× RJ 45 Cat. 6
for UTP cable
connectors black
DSE 98-00000-000000
-  **communication sockets Cat. 6 double**
2× RJ 45 Cat. 6 shielded
for STP cable
connectors black
DSE 74-00000-000000
-  **communication sockets Cat. 6A double**
2× RJ 45 Cat. 6A shielded
for STP cable
connectors black
DSE 75-00000-000000

-  **TV+R sockets terminal**
attenuation 1 dB, 350 mA, 24 V DC
for coaxial cables of diameter 4.5–8.3 mm
designation on the product: ZAR 1/K
DSE 94-00000-000000
-  **TV+R sockets through**
branching attenuation 9 dB
for coaxial cables of diameter 4.5–8.3 mm
designation on the product: ZAP 9/K
DSE 95-00000-000000
-  **TV+R sockets through**
branching attenuation 14 dB
for coaxial cables of diameter 4.5–8.3 mm
designation on the product: ZAP 14
DSE 96-00000-000000
-  **TV+R+SAT sockets**
terminal, attenuation 1 dB, 300 mA, 24 V DC
for coaxial cables of diameter 4.5–8.3 mm
designation on the product: ZAR-SAT 1.4/K
DSE 97-00000-000000
-  **TV+R+SAT sockets**
through, attenuation 10 dB, 300 mA, 24 V DC
for coaxial cables of diameter 4.5–8.3 mm
designation on the product: ZAR-SAT 10/P3
DSE 99-00000-000000
-  **TV+SAT+SAT sockets**
through, attenuation 10 dB, 300 mA, 24 V DC
for coaxial cables of diameter 4.5–8.3 mm
designation on the product: ZAR-SAT 10/P3
DSE 76-00000-000000
-  **passive switch for intelligent systems**
50 mA, 12 or 24 V DC
DSE KC-00000-000000
-  **AUDIO-VIDEO sockets**
mono (1+1)
DSE 71-00000-000000
-  **AUDIO-VIDEO sockets**
stereo (2+1)
DSE 72-00000-000000
-  **terminal for potential equalization**
protective bonding outlet 5× terminal
up to 2.5 mm², 1× terminal up to 6 mm
DSE 79-79001-000000
-  **2P+PE sockets**
single
16 A, 250 V AC
DSE Z1-810YY-000000

-  **2P+PE sockets**
single with safety shutters
16 A, 250 V AC
DSE 89-890YY-000000
-  **2P+PE with OP sockets**
single with safety shutters and overvoltage protection,
(LIGHT INDICATION) 16 A, 250 V AC, I max 4.5 kA,
Up < 1.2kV
DSE 84-840YY-000000
-  **2P+PE with OP sockets**
single with safety shutters and overvoltage protection,
(AUDIBLE ALARM) 16 A, 250 V AC, Up < 1.2 kV
DSE 80-890YY-000000
-  **2P+PE schuko sockets ****
single
16 A, 250 V AC
DSE S1-830YY-000000
-  **2P+PE schuko sockets ****
single with safety shutters
16 A, 250 V AC
DSE S2-830YY-000000
-  **2P+PE with OP schuko sockets ****
single with safety shutters and overvoltage protection,
(LIGHT INDICATION), 16 A, 250 V AC
DSE S3-860YY-000000
-  **2P+PE, IP 44 sockets**
with lid and safety shutters 16 A, 250 V AC
DSE 89-530YY-000000

Available colour only 01, 30, 31, 32, 33.
IP 44 outlet is always supplied with transparent (milk white) lid.
-  **2P+PE schuko sockets**
with lid and safety shutters 16 A, 250 V AC
DSE S2-550YY-000000

Available colour only 01, 30, 31, 32, 33.
IP 44 outlet is always supplied with transparent (milk white) lid.
-  **2× (2P+PE) sockets**
double
16 A, 250 V AC
DSE 82-820YY-000000
-  **2× (2P+PE) sockets**
double with safety shutters (ELEGANT only)
16 A, 250 V AC
DSE 87-870YY-000000
-  **2× (2P+PE) with OP sockets**
double with safety shutters and overvoltage
protection (LIGHT INDICATION)
16 A, 250 V AC, I max 4.5 kA, Up < 1.2 kV
DSE 85-850YY-000000

i ** Availability of schuko sockets is upon request.

elegant

aqua IP 44

*safety first not only
in your bathroom*



IP 44 switches and sockets

ELEGANT AQUA series devices are designed for flush mounting and are supplied with IP 44 protection. These can be used in dusty, damp environments (bathrooms, warehouses, workshops, garages etc.) or outdoor areas.

XXXX = YY =	2001 - olive grey * 01 - white	1901 - steel grey 01 - white	1801 - cappuccino 01 - white	2101 - nut brown 01 - white	1101 - ruby red * 01 - white	
XXXX = YY =	0401 - vanilla yellow * 01 - white	0901 - sunflower yellow * 01 - white	0601 - peach orange * 01 - white	1001 - signal brown 01 - white	0101 - snow white 01 - white	
XXXX = YY =	0501 - sandy beige 01 - white	0801 - ice green * 01 - white	0301 - smoke grey 01 - white	0201 - anthracite black 01 - white		
XXXX = YY =	3030 - aluminium 01 - white	3131 - graphite 01 - white	3232 - gold 01 - white	3333 - titanium 01 - white	single sockets with transparent lid	
XXXX = YY =	3030 - aluminium 30 - aluminium	3131 - graphite 31 - graphite	3232 - gold 32 - gold	3333 - titanium 33 - titanium	schuko sockets with transparent lid	



Only the colour combinations shown are available for the IP 44 in the ELEGANT range. The IP 44 sockets is always supplied with a transparent (milk white) lid.



ORDER CODE:
DSE 00-510YY-51XXXX



IP 44 protection can be used with sockets and switches (arrangements 1, 2, 6, 7, 1/0, 5, 6+6, 1/0+1/0, 1+1/0).

* Until stocks are sold out.

elegant

vacuum sockets



vacuum sockets

ELEGANT vacuum sockets are designed to be installed in modern interiors. Colours and shape perfectly match ELEGANT switches and socket sockets. They are compatible with BEAM central vacuuming systems.

XXXX = YY =	2001 - olive grey * 01 - white	1901 - steel grey 01 - white	1801 - cappuccino 01 - white	2101 - nut brown 01 - white	1001 - signal brown 01 - white	0201 - anthracite black 01 - white
XXXX = YY =	0401 - vanilla yellow * 01 - white	0901 - sunflower yellow * 01 - white	0601 - peach orange * 01 - white	1101 - ruby red * 01 - white	0501 - sandy beige 01 - white	0801 - ice green * 01 - white
XXXX = YY =	3001 - aluminium 01 - white	3101 - graphite 01 - white	3201 - gold 01 - white	3301 - titanium 01 - white	0301 - smoke grey 01 - white	0101 - snow white 01 - white
XXXX = YY =	3030 - aluminium 01 - white	3131 - graphite 01 - white	3232 - gold 01 - white	3333 - titanium 01 - white		
XXXX = YY =	3030 - aluminium 30 - aluminium	3131 - graphite 31 - graphite	3232 - gold 32 - gold	3333 - titanium 33 - titanium	assembly plate DSE 26-00000-00000	



ELEGANT vacuum cleaners are only available in the colour combinations shown. The mounting plate is not included, but you can order it separately as an accessory. Vacuum sockets are supplied in set only.



ORDER CODE:
DSE 73-730YY-73XXXX

* Until stocks are sold out.



elegant

medical



Colour sockets are used to clearly resolve circuits with different types of back-up power supply (distributions for healthcare, data and computer networks, etc.). The ELEGANT Medical line can be combined with other ELEGANT switches and sockets for a complex wiring solution within a building.

colour coding of socket sockets



snow white frame / cover green medical

green - critical circuit

Green sockets cover plates are used for connecting equipment that must have restored provision of emergency power from the main emergency source (usually a diesel generator with auto-start) within a maximum of 2 minutes of a power failure from the primary source. This emergency source supplies electricity for the entire duration of the interruption of the primary source.



snow white frame / cover yellow medical

yellow - medical isolated circuit

Yellow sockets cover plates are used exclusively for connecting medical equipment essential for sustaining the life and health of patients. The nature of use of this equipment means that its power cannot be interrupted in the event of a fault within the circuit. A medical isolated power system therefore allows operation to continue even in such situations, while the circuit failure is visually and acoustically signalled. Since a further failure could then lead to interruption of system power, it is vital to repair the failure immediately after finishing the ongoing operation. Medical isolated power system is powered from critical circuits. This means that emergency power from the main back-up source is secured within 2 minutes.



snow white frame / cover orange medical

orange - highly critical circuit

Orange sockets cover plates are designated for power sockets of highly critical circuits whose power may not be interrupted for more than 15 seconds. This will principally involve a medical isolated power system with an even higher level of provision of emergency electrical power supply, because the primary winding of its protective isolation transformer is fed from the UPS, almost always operated in on-line mode (without interruption of the power supply to connected equipment). As the emergency source will have a limited output and operating time, this type of outlet may only be used to supply medical equipment which supports or substitutes basic life functions, which does not have emergency power provided by other means, and for which the power recovery time of the main emergency source is too long.



snow white frame / cover snow white

white - less critical circuit

White sockets cover plates are designated for connecting routine equipment and appliances (cookers, refrigerators, coffee machines, cleaning equipment etc.). Medical equipment can be connected to these circuits only in exceptional, emergency situations, when there is no power in the other sockets (green, yellow or orange).



snow white frame / cover signal brown

brown - less critical circuit

Brown cover plates designate sockets of less critical circuits with their protection increased by residual-current devices. They are designated for medical and non-medical equipment where increased protection against electric shock is appropriate or necessary. A connection to a less critical circuit with a residual-current device is designated by the letter code MF.



snow white frame / cover red medical

red - less critical circuit

Red cover plates are recommended for sockets designated for connecting computers and their accessories into circuits with their own UPS.

sets



single elegant medical sockets (2P+PE)



single elegant medical sockets with safety shutters (2P+PE)



single elegant medical sockets with safety shutters and overvoltage protection (2P+PE) LIGHT INDICATION



double elegant medical sockets 2x (2P+PE)



double elegant medical sockets with safety shutters 2x (2P+PE)



double elegant medical sockets with safety shutters and overvoltage protection 2x (2P+PE) LIGHT INDICATION



single sockets with operational status indicator



terminal for equalizing potential (sockets for protective bonding)

covers

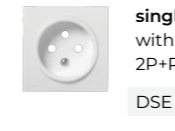

single sockets cover with safety shutters 2P+PE
DSE 00-810YY-000000



double sockets cover with safety shutters 2x (2P+PE)
DSE 00-870YY-000000

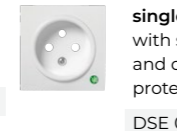

single sockets cover with safety shutters and overvoltage protection 2P+PE
DSE 00-840YY-000000

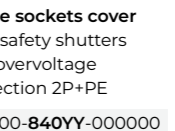

double sockets cover with safety shutters and overvoltage protection 2P+PE
DSE 00-850YY-000000

medical cover colours

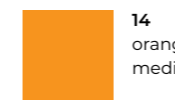

14 orange medical



15 yellow medical

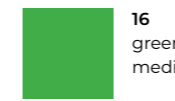

16 green medical



17 red medical

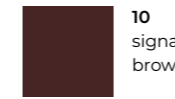

10 signal brown

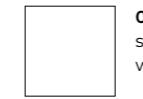

01 snow white



Colour tones may differ slightly from reality.



ORDER CODE:
DSE 00-YYYYY-000101



thermostats and motion sensors

avant, nexa, retro,
decente, elegant design

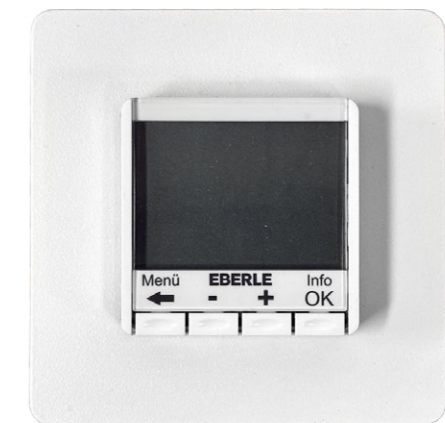

Various thermostats and motion sensors can be aligned in the same design as the rest of the switches and sockets. Motion sensors automatically switch most often lighting and are useful mainly in the premises with frequent movement of people. Thermostats observe room temperature and optimally regulate heating, some allow you to set different time scenarios. Choose reliable devices from a wide range of materials and colours among our AVANT, NEXA, RETRO,DECENTE or ELEGANT products.



EBERLE

thermostats



PRODUCT	THERMOSTAT RTR-E 8011-50	THERMOSTAT FRE L2A-50 LIMITER	THERMOSTAT FIT 3U	THERMOSTAT FIT 3U	THERMOSTAT FIT 3U
order code	DSE 2T, DSD 2T*, DSR 2T, DSN 2T, DSA 2T	DSE 3T, DSD 3T*, DSR 3T, DSN 3T, DSA 3T	DSE 4T, DSD 4T*, DSR 4T, DSN 4T, DSA 4T	DSE 4T, DSD 4T*, DSR 4T, DSN 4T, DSA 4T	DSE 4T, DSD 4T*, DSR 4T, DSN 4T, DSA 4T
description	analogue thermostat under plaster mounting ROOM (modular 50x50)	analogue thermostat under plaster mounting FLOOR (modular 50x50) with sensor	digital thermostat under plaster mounting ROOM (modular 50x50)	digital thermostat under plaster mounting FLOOR** (modular 50x50)	digital thermostat under plaster mounting COMBINED** (modular 50x50)
dimensions (h×w×d)	84×89×42 mm	84×89×42 mm	84×89×42.5 mm	84×89×42.5 mm	84×89×42.5 mm
temperature range	10–40 °C	10–40 °C	5–30 °C	10–40 °C	10–40 °C room a 10–40 °C floor
contact (relay)	switching (AC 230 V)	switching (AC 230 V)	switching (AC 230 V)	switching (AC 230 V)	switching (AC 230 V)
working voltage	AC 230 V 50 Hz	AC 230 V 50 Hz	AC 230 V 50 / 60 Hz	AC 230 V 50 / 60 Hz	AC 230 V 50 / 60 Hz
switching current	10 (4) A	10 (4) A	10 mA–10 (4) A	10 mA–16 (4) A	10 mA–10 (4) A
hysteresis	cca 1 K	cca 1 K	in steps of 0.1°C	in steps of 0.1°	in steps of 0.1°
regulation	ON/OFF	ON/OFF	PWM or ON/OFF	PWM or ON/OFF	PWM or ON/OFF
protection	IP 30	IP 30	IP 30	IP 30	IP 30

i * If you order an ELEGANT frame, order the device with code DSE xT. If device is used with DECENTE design, proceed with code DSD xT. If device is used with RETRO design, proceed with code DSR xT. NEXA Quadro frame is used with DSN XT device + DSN RQ-T0000-11xx frame. Avant frame is used with DSA XT device + DSA RA-T0000-11xx frame.
** Floor sensor is sold separately.



PRODUCT	FLOOR SENSOR
order code	DSE 56, DSD 56, DSR 56, DSN 56, DSA 56
description	floor sensor for EBERLE thermostats
dimensions (h×w×d)	4 m
temperature range	0–70 °C

i If you order a floor sensor for thermostats in the ELEGANT range, use code DSE 56, in the DECENTE range code DSD 56, in the RETRO range code DSR 56, in the NEXA range code DSN 56, in the AVANT range code DSA 56.

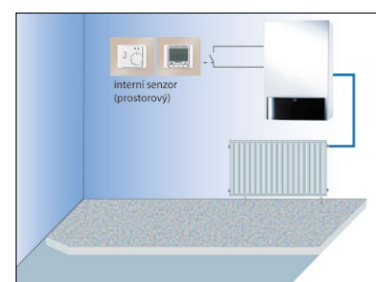

ROOM THERMOSTATS
Allow measurement of room temperature using an intergrated room sensor and regulation (swit-ching) of e.g. central heating boilers (potential-free contact).

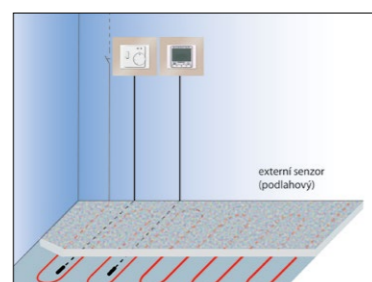

FLOOR THERMOSTATS
Used mainly for controlling the temperature of underfloor heating using an external sensor. Can also be used for sensing and regulation in other media (tubes, liquids, solid and loose materials etc.).

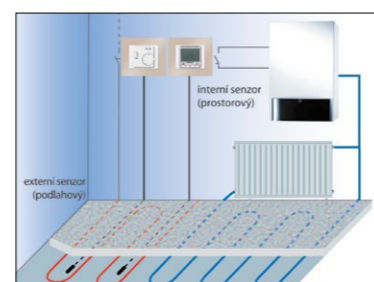

COMBINED THERMOSTATS
Temperature can thus be regulated using an internal or external sensor. Used with e.g. underfloor heating, where room sensor works as the main sen-sor and floor sensor as protection against overhea-ting.



PRODUCT	PIR SENSOR 180-R	PIR SENSOR 180-T	PIR SENSOR 180-R-2D	PIR SENSOR 180-TR
order code	DSE B1 / DSD B1' / DSR B1 - B1001	DSE B2 / DSD B2' / DSR B2 - B1001	DSE B3 / DSD B3' / DSR B3 - B1001	DSE B4 / DSD B4' / DSR B4 - B1001
description	Wall-mounted motion detector with acoustic sensor. Relay version in three-wire technology. Automatic extension of transition time through sounds. Possible manual button control.	Wall-mounted motion detector with acoustic sensor. Triac design with 2-wire technology, without zero conductor. Only for ohmic loads. Automatic extension of transition time through sounds.	Wall-mounted motion detector with acoustic sensor. Relay design with 2-wire technology thanks to built-in battery. Automatic extension of transition time through sounds.	Wall-mounted motion detector designed for switching staircase automatic lights. Triac design with 2-wire without zero-conductor. It guarantees perfect operation with LUXOMAT® SCT1 (up to 10 detectors per device).
dimensions (h×w×d)	mounting depth 36 mm	mounting depth 36 mm	mounting depth 36 mm	mounting depth 36 mm
power	2 300 W, cos φ = 1 1 150 W, cos φ = 0,5	300 W / min. 40 W cos φ = 1 not suitable for LED	2 300 W cos φ = 1 not suitable for LED	max. 200 mA / 230 V
voltage	110–240 V AC 50 / 60 Hz	110–240 V AC 50 / 60 Hz	110–240 V AC 50 / 60 Hz 5× NiMh / 30 AAAA, 1.2 V / 200 mA	110–240 V AC , 50 / 60 Hz operation via a staircase automat (230 V)
coverage angle	180° vertically	180° vertically	180° vertically	180° vertically
range	max. 10 m	max. 10 m	max. 10 m	max. 10 m
twilight setting	2–2 000 lux	2–2 000 lux	2–2 000 lux	2–2 000 lux
time setting	15 s – 16 min nor bell impulse	15 s – 16 min nor bell impulse	15 s – 16 min nor bell impulse	impulse duration 0.1 s
protection	IP 20 / class II	IP 20 / class II	IP 20 / class II	IP 20 / class II

PRODUCT	PIR SENSOR 180 M 2C	PIR SENSOR 180 S	PIR SENSOR 180-R-11-48V	PIR SENSOR 180-KNX
order code	DSE B5 / DSD B5' / DSR B5 - B1001	DSE B6 / DSD B6' / DSR B6 - B1001	DSE B7 / DSD B7' / DSR B7 - B1001	DSE B8 / DSD B8' / DSR B8 - B1001
description	Wall-mounted presence detector, master model. Switching channel for switching the light on. Potential-free HVAC contact. Possible extension of detection range with slave devices. Automatic extension of transition time through the sounds.	Wall-mounted presence detector, slave model. To extend the detection range of mas-ter model. Compatible with all master devices except: PD4-M- DS-FC, 11-48Vdevices, PD9-M- SDB.	Wall-mounted motion detector with acoustic sensor with operating voltage 11–48 V. Potential-free switching contact. Possible manual button control.	Wall-mounted presence detector KNX with acoustic sensor and integrated BUS connector. When using B.E.G._Occupancy detector_928XX_V5.0, several operating modes are available:
dimensions (h×w×d)	mounting depth 36 mm	mounting depth 36 mm	mounting depth 36 mm	mounting depth 36 mm
power	channel 1 (lighting check): 2 300 W, cos φ = 1 1 150 VA, cos φ = 0,5 channel 2 (HVAC check): 3 A, 230 V, cos φ = 1	slave	3 A cos φ = 1	KNX
voltage	110–240 V AC 50 / 60 Hz	110–240 V AC 50 / 60 Hz	11–48 V AC / DC	KNX
coverage angle	180° vertically	180° vertically	180° vertically	180° vertically
range	max. 10 m	max. 10 m	max. 10 m	max. 10 m
twilight setting	2–2 000 lx	2–2 000 lx	2–2 000 lx	2–2 000 lx
time setting	channel 1: 15 s – 30 min, impuls channel 2: 5 min – 120 min, impuls, alarm impuls	impuls 2 s or 9 s	impuls 15 s – 30 min	
protection	IP 20 / class II	IP 20 / class II	IP 20 / class II	IP 20 / class II

i * Motion sensors can be implemented into ELEGANT (use DSE XX), DECENTE (use DSD XX) or RETRO design (use DSR XX).



Passive switches for intelligent systems

avant, nexa, retro,
decente, elegant design



Passive switches represent a modern and elegant solution for intelligent homes that emphasize comfort, efficiency and aesthetics. Thanks to their compact design, fast response and ability to connect with smart systems, they enable easy control of lighting and other household devices. They are an ideal choice for those who want to increase the comfort of their living space while maintaining a clean, minimalist interior design.

Overall, they represent a flexible, economical and design clean solution for anyone who wants to take their home to a higher level of comfort and automation.

**For control
are used:**

- passive switches
- touch panels
- devices using iOS or Android
- control via TV / LAN
- sensors and other controllers connected to the bus

accessories



spacer VK1
fills up the gap between installation box and fitting
DSE 29-00000-000000



spacer VK2
fills up the gap between installation box and fitting
DSE 30-00000-000000



HDMI-A keystone
female-female, 4K, 60 Hz, 1 pc
3453685 black
3453686 white



USB-A keystone-charger
2.1 A, 10,5 W, 1 pc
3450546 black
3453672 white



USB-C keystone-charger
2.1 A, 10,5 W, 1 pc
3453678 black
3453679 white



TV keystone
IEC (koax) male - female, Z=75 Ω
3453702 black
3453701 white



SAT keystone
female - female, Z=75 Ω
3453691 black
3453692 white



RJ45 CAT5E keystone
UTP unshielded
3450062 black
3450075 white



RJ45 CAT6 keystone
UTP unshielded
3450063 black
3453676 white



PC connector Cat. 5E
RJ 45 black plastic
set of 2 pcs
for UTP cable
DSE 33-00000-000000



PC connector Cat. 6
RJ 45 black plastic
set of 2 pcs
for UTP cable
DSE 34-00000-000000



PC connector Cat. 6 shielded
RJ 45 Cat. 6
set of 2 pcs
for STP cable
DSE 24-00000-000000



PC connector Cat. 6A shielded
RJ 45 Cat. 6A
set of 2 pcs
for STP cable
DSE 25-00000-000000

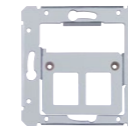

support frame for PC connectors
for DECENTE and ELEGANT line
DSE 35-00000-000000

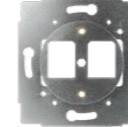

support frame for HDMI, USB-A, USB-C, PC connectors
for DECENTE line
DSD 35-00000-0000



support frame for data socket
for AVANT line
DSA 90-00000



supplementary frame for the DECENTE range
DSD 00-00000-R100



supplementary frame for the DECENTE Mini range
DSI 00-00000-R100

accessories



glow lamp (for DECENTE line)
230 V, 2 MA
DSD 3A-00000-000000 orange
230 V, 0,5 MA
DSD 3B-00000-000000 green
DSD 3C-00000-000000 blue



glow lamp (for ELEGANT line)
230 V, 2 MA
DSE 3A-00000-000000 orange
230 V, 0,5 MA
DSE 3B-00000-000000 green
DSE 3C-00000-000000 blue



connector CINCH AUDIO-VIDEO mono
set of 2 pcs
DSE 38-00000-000000



connector CINCH AUDIO-VIDEO stereo
set of 3 pcs
DSE 39-00000-000000



fixative spurs (claws)
set of 2 pcs
DSE 37-00000-000000



single box for strip distribution systems
(only for ELEGANT)
DSE 31-00000-000000



double outlet box for strip distribution systems
(only for ELEGANT)
DSE 36-00000-000000



5103 MDE mounting plate
for central vacuum cleaner sockets
DSE 26-00000-000000

i Supplementary frames are installed between the switch frame and the wall and are intended for DECENTE and DECENTE Mini frames.



wiring diagrams

switch arrangement 1 (singlepole switch)

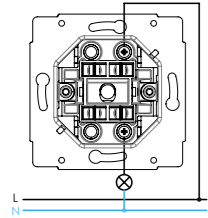

Used to control one device or one device group from one place. For other switches there is only one device in a given switching circuit considered.

switch arrangement 1+1+1

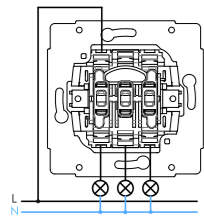

switch arrangement 2 (twopole switch)

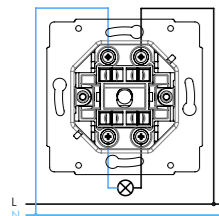

Usually used where it is needed to turn off work and central wire at the same time.

switch arrangement 5 (serial change-over switch, singlepole) two circuit switch with switched-off position)

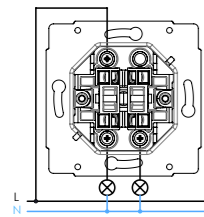

For controlling two electrical circuits from one spot.

single outlet

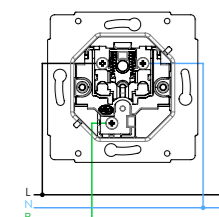

Connects electrical device to electricity grid. Safety sockets are also available: outlet with safety shutters, IP 44 outlet.

double sockets

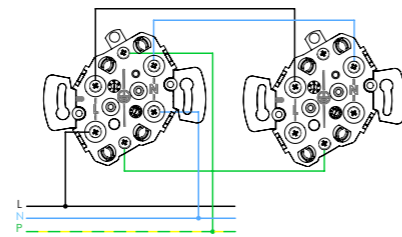

Double outlets connects electrical devices to electricity grid

switch arrangement 6 stair switch (change-over switch), singlepole 2-way switch without switched off position

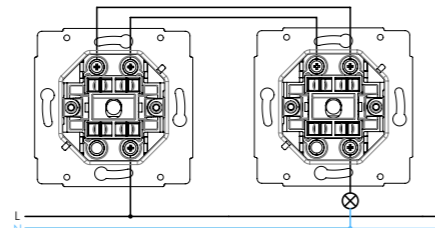

Classic control of staircase or hallway lighting from two spots.

switch arrangement 6+6 double stair switch (serial change-over switch)

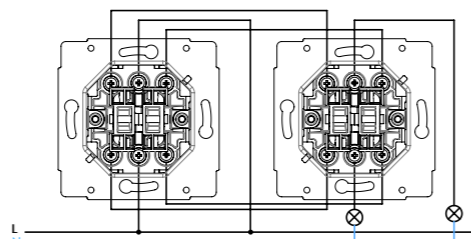

For controlling two electrical circuits from two spots.

switch arrangement 6+7+6 change-over switch - cross-bar switch - change-over switch

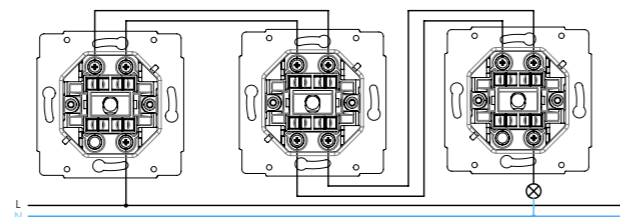

Between two switches 6, any number of switches 7 can be placed.

wiring diagram for retro (cam switch)

arrangement 1

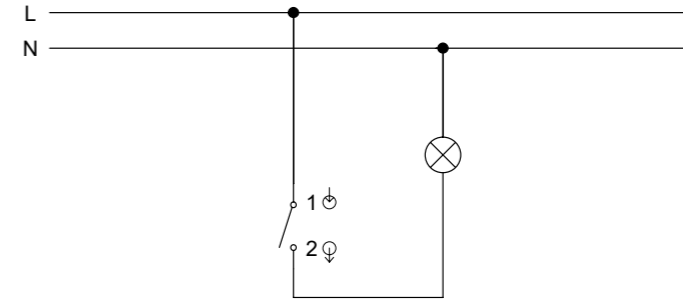

arrangement 2

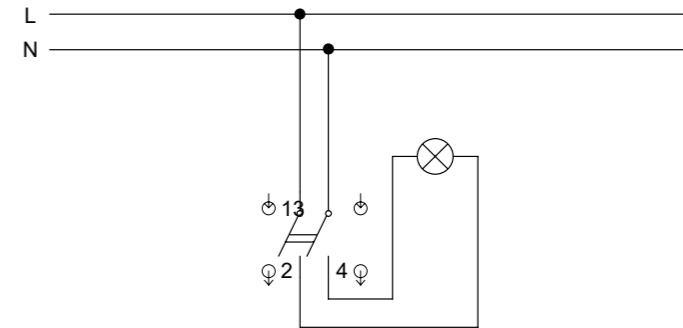

arrangement 5

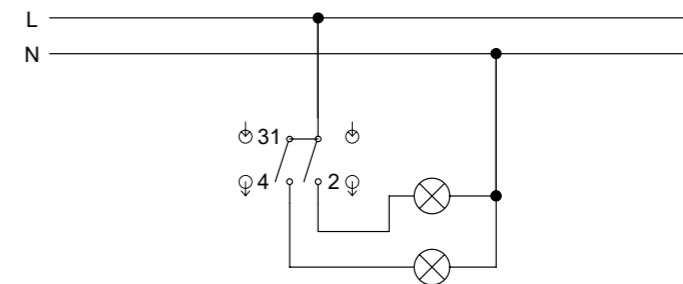

arrangement 6

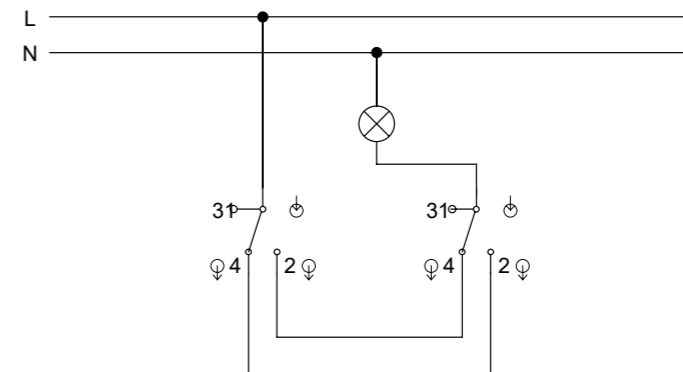

arrangement 6+7+6

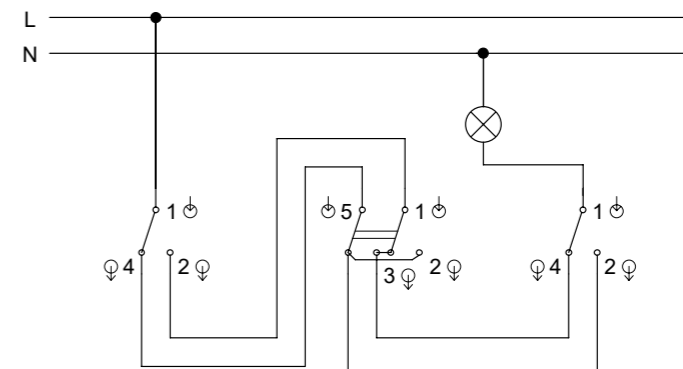

avant

frames

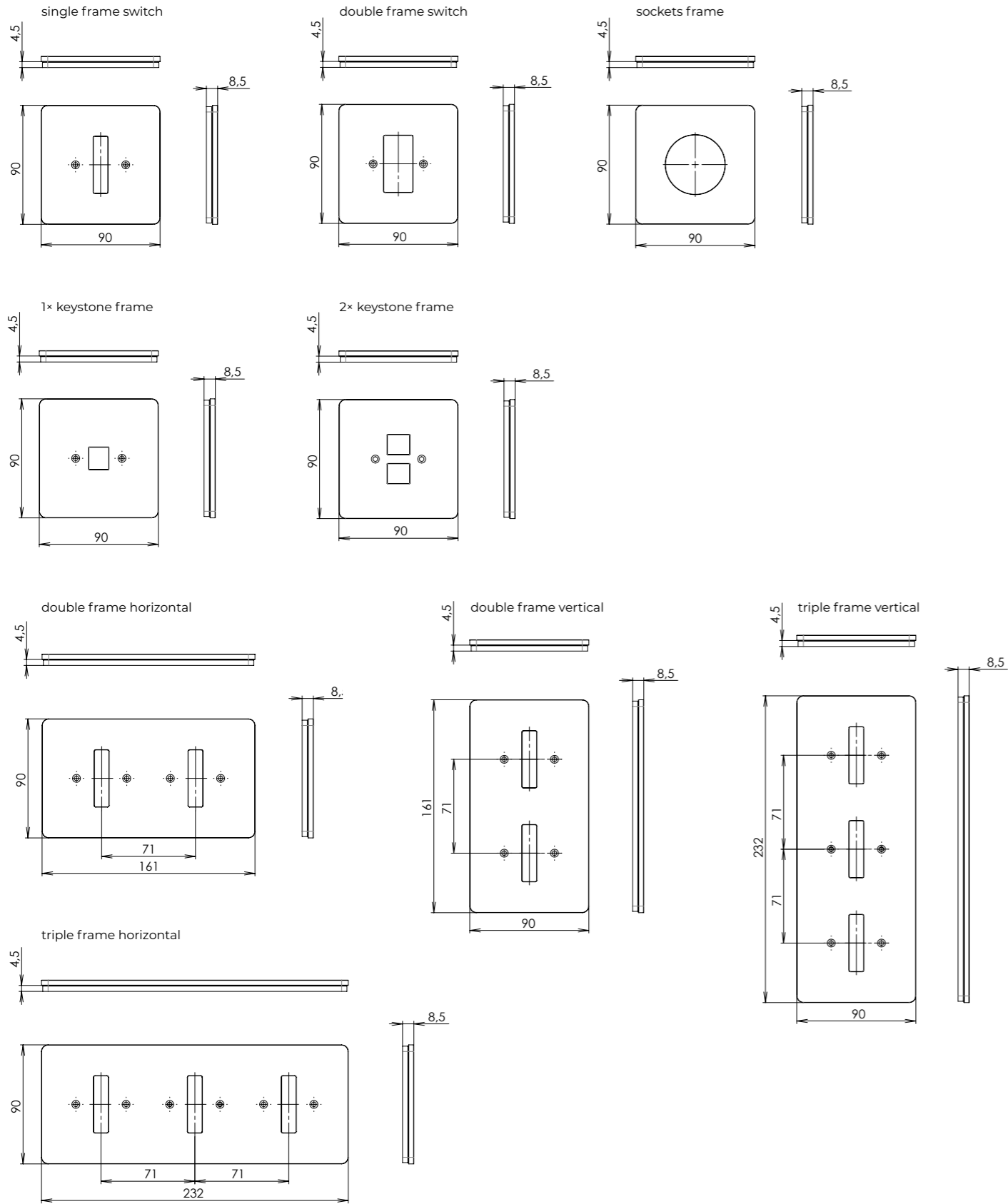

avant

fittings

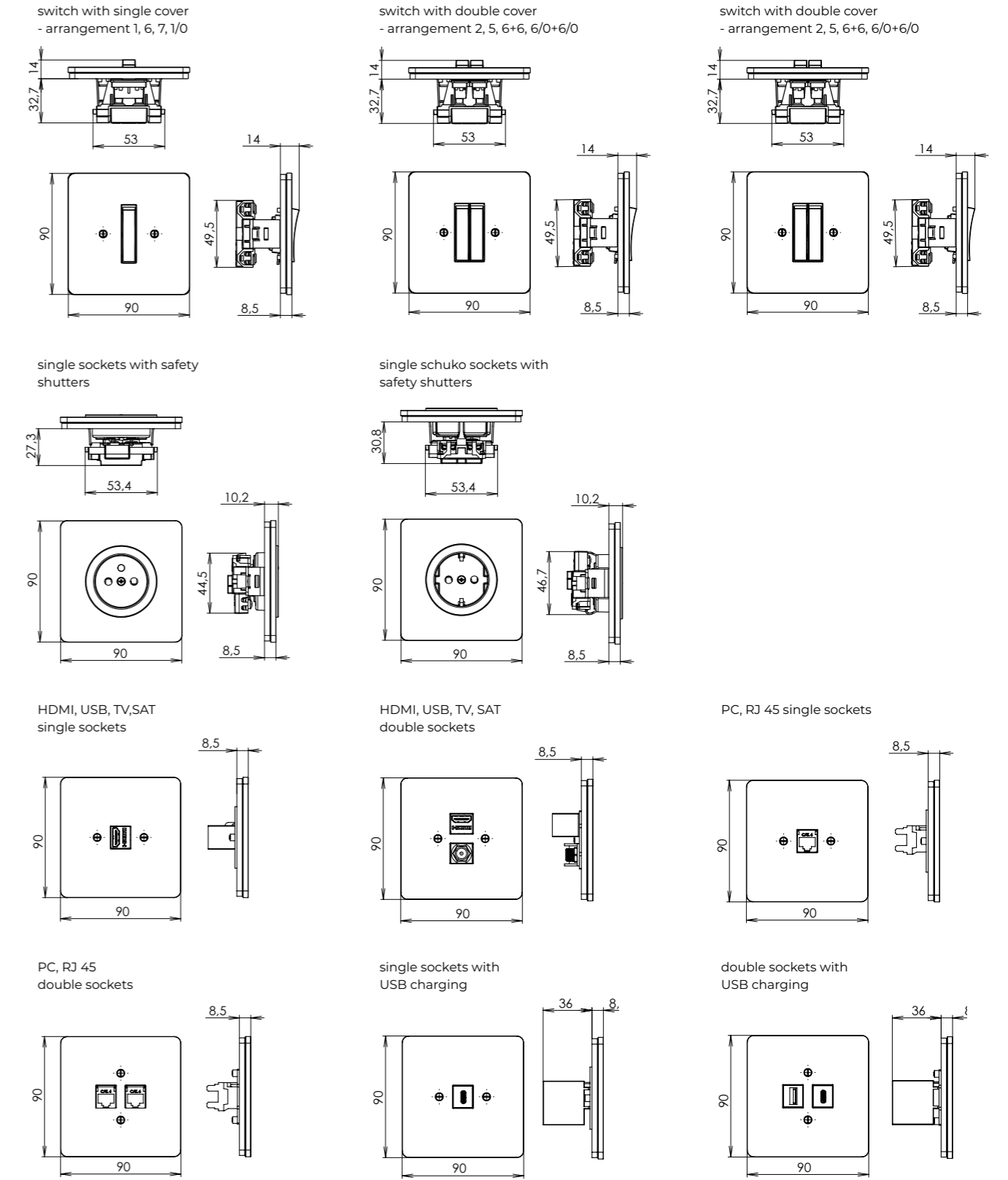

nexa

frames rondo

single frame

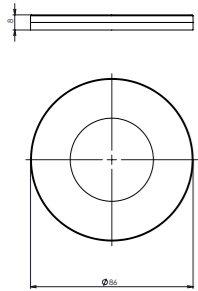

double frame horizontal and vertical

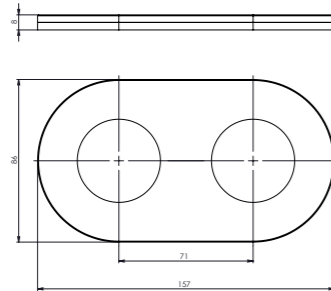

triple frame horizontal and vertical

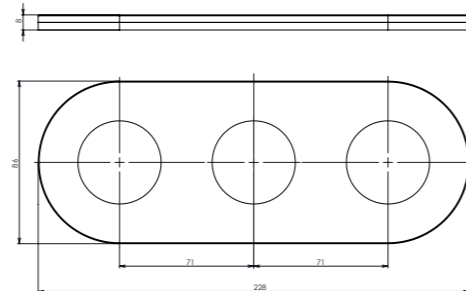

frames quadro

single frame

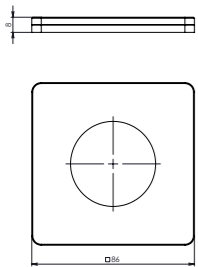

double frame horizontal and vertical

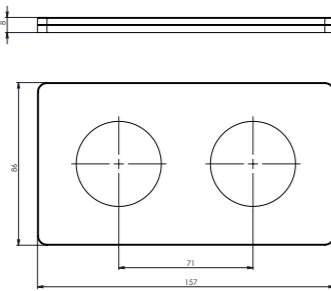

triple frame horizontal and vertical

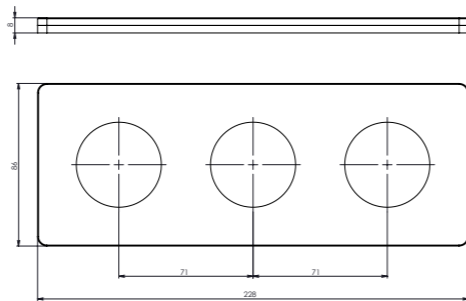

fittings rondo / quadro

house switch arrangement 1, 2, 5, 6

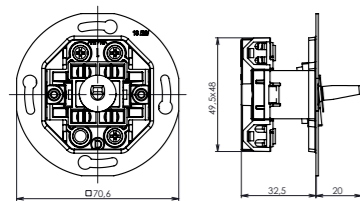

house switch arrangement 5, 6+6, 6/0+6/0

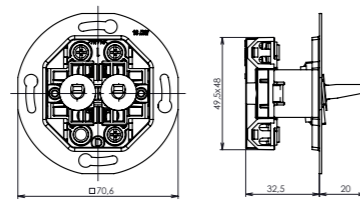

nexa

fittings rondo / quadro

house switch with frame arrangement 1, 2, 6, 7, 1/0

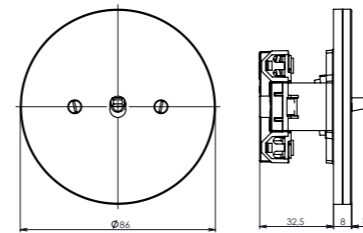

house switch with frame arrangement 5, 6+6, 6/0+6/0

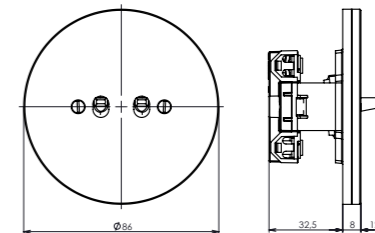

single sockets

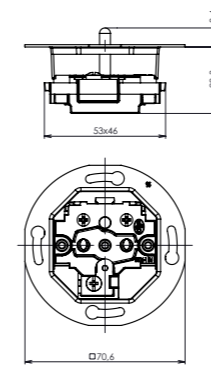

single sockets with frame

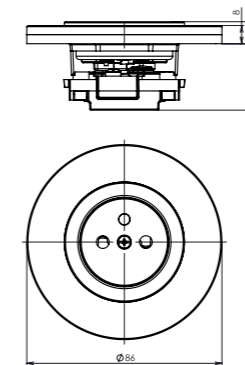

schuko single sockets

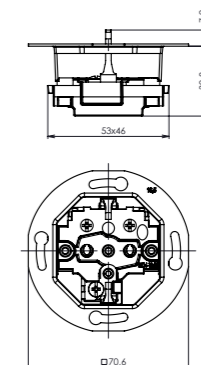

schuko single sockets with frame

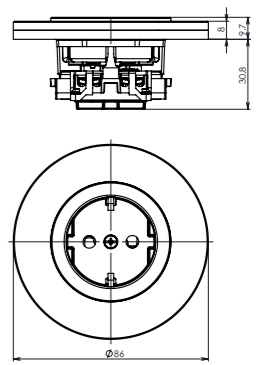

hdmi, usb, tv, sat, pc, rj 45 sockets + outlet charging

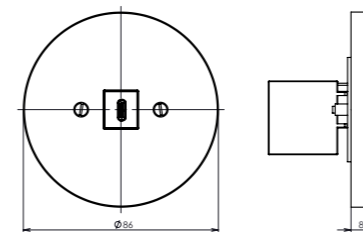

single socket british standard

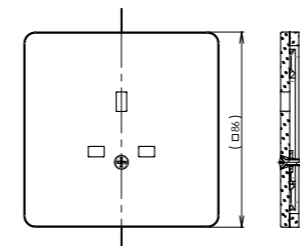

double socket british standard

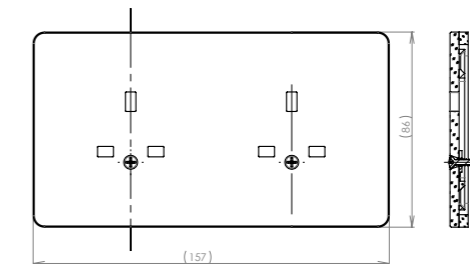

thermostat - only in quadro collection

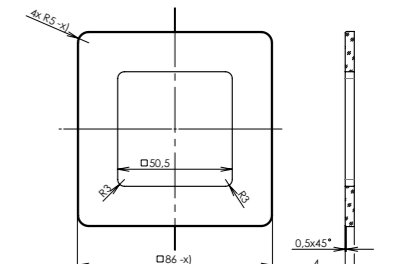

retro

frames

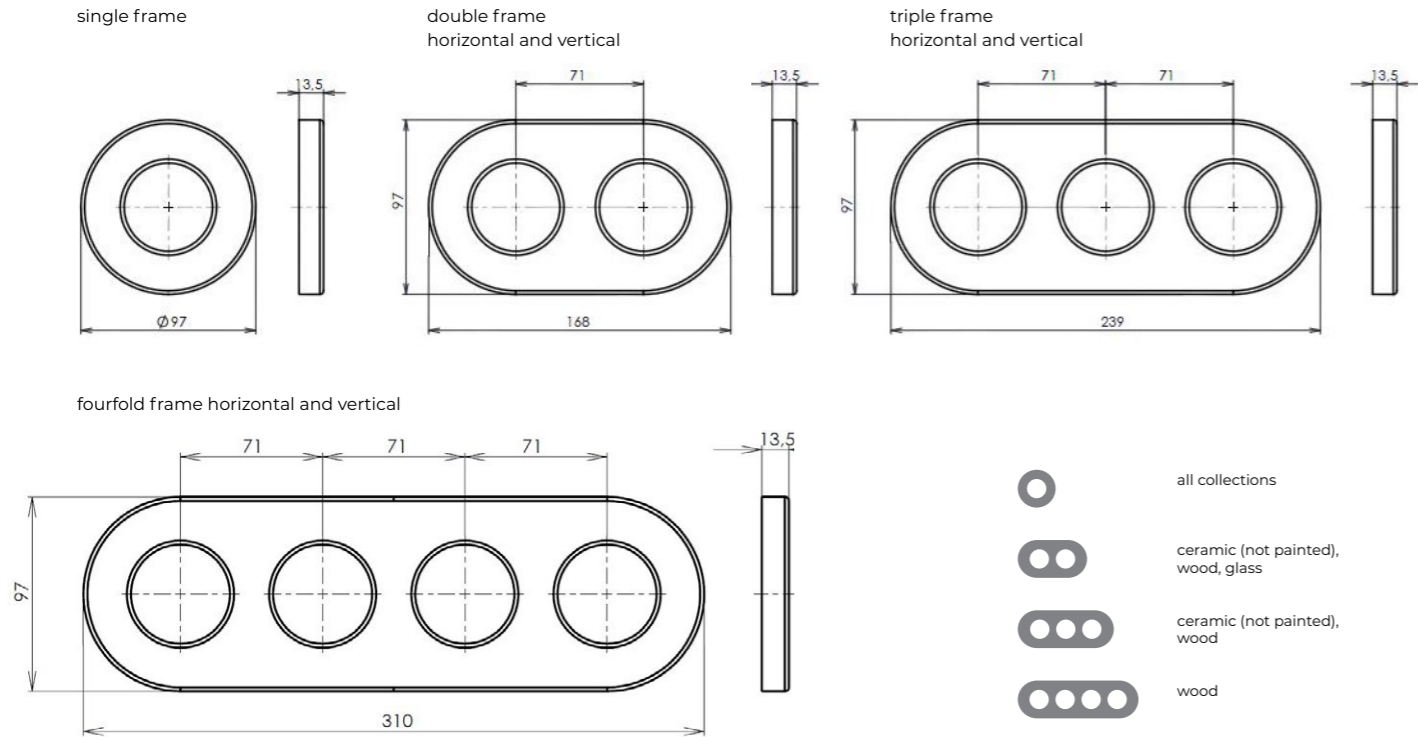

i Multiple frames can be installed both horizontally and vertically (are compatible).

frames for glass collection

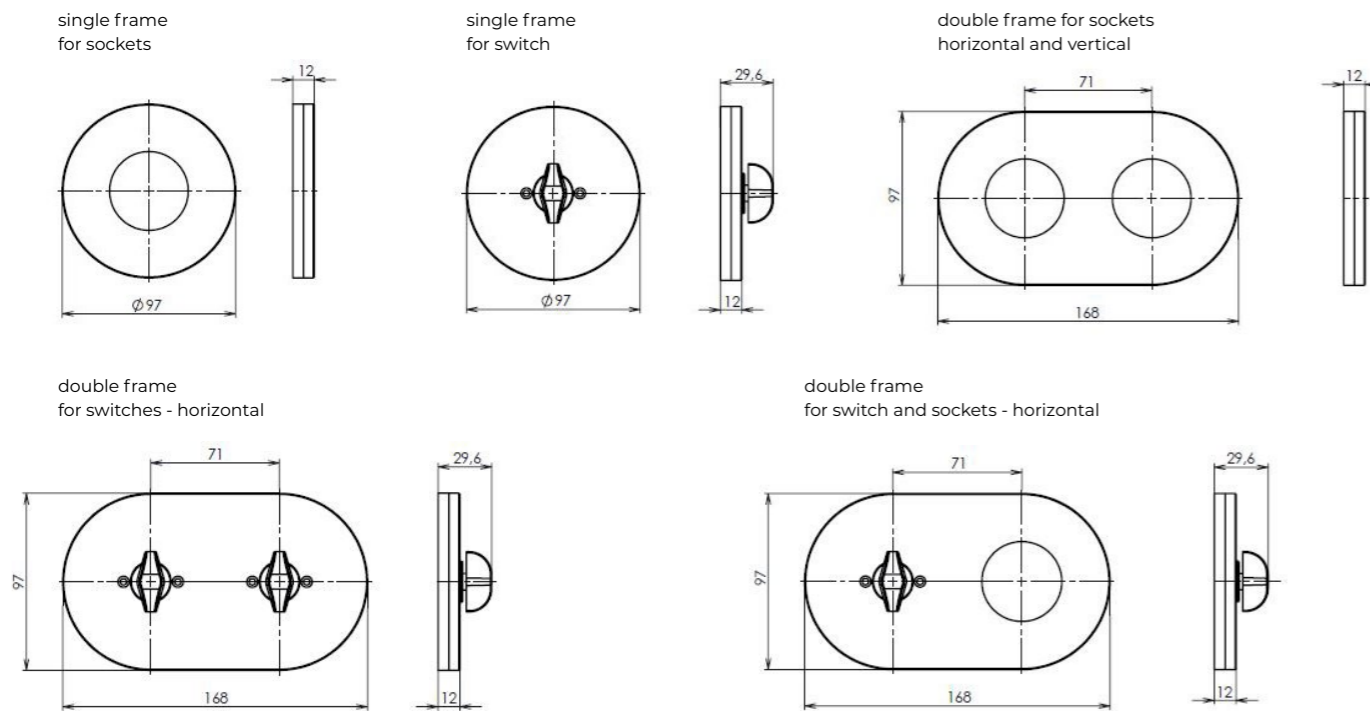

retro

fittings ceramic, wood collection

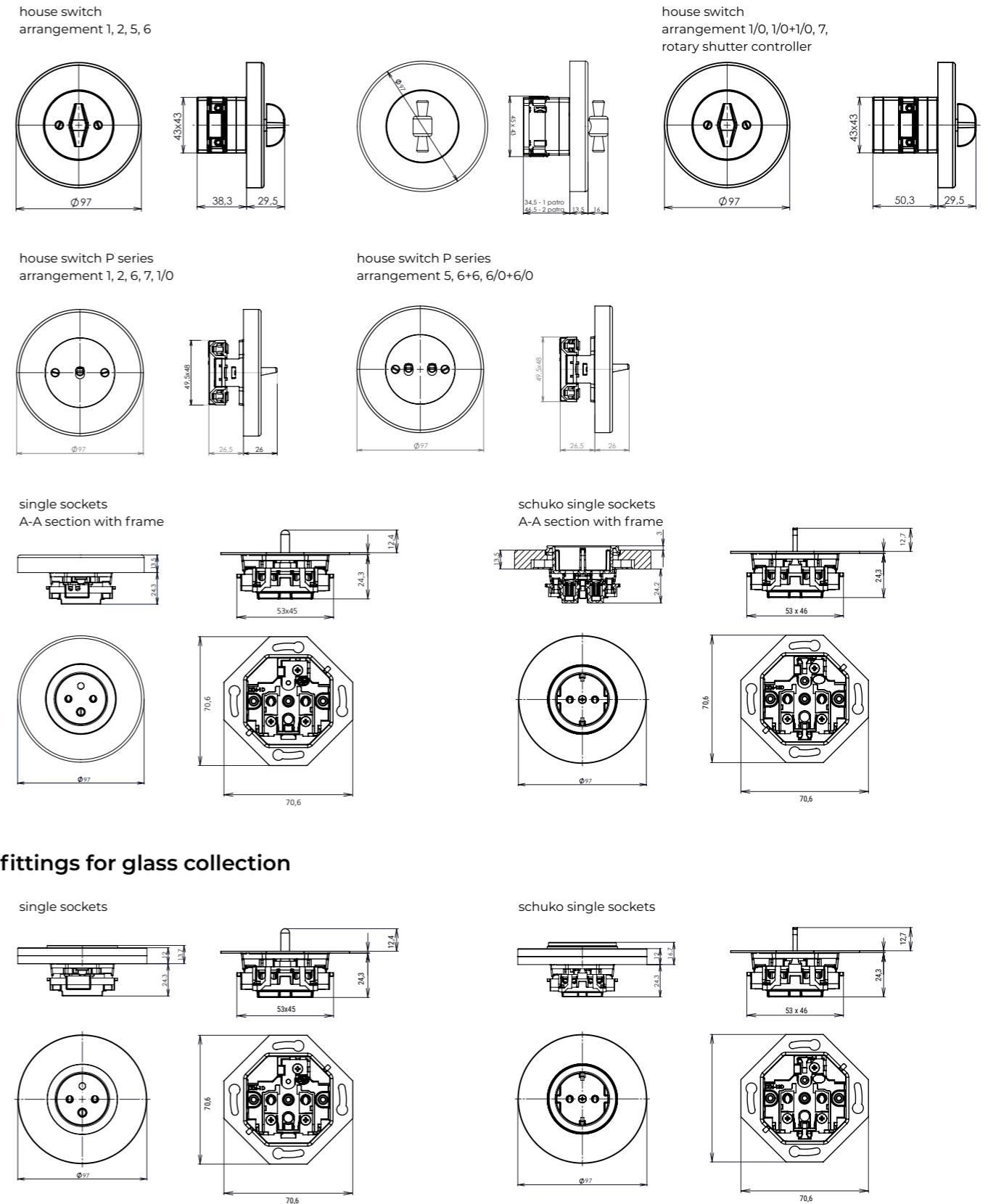

retro

fittings

HDMI, USB,TV,SAT sockets

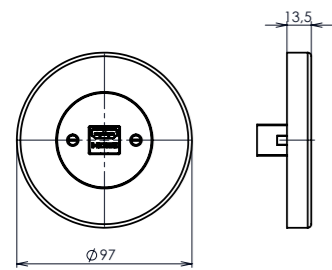

PC, RJ 45 sockets

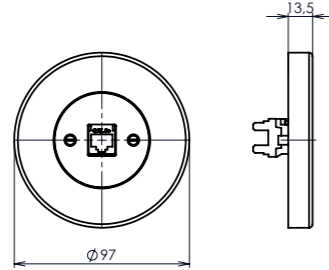

sockets with USB-A charging

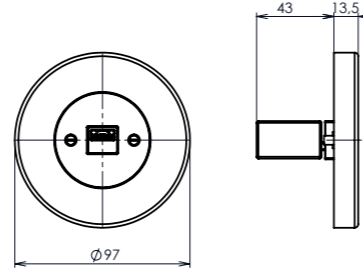

HDMI, USB,TV,SAT sockets glass

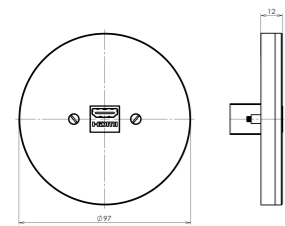

PC, RJ 45 sockets glass

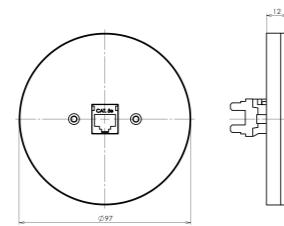

sockets with USB-A charging glass

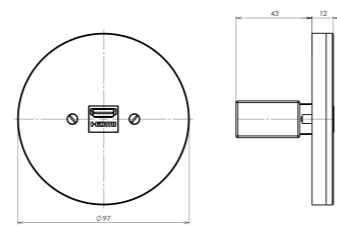

motion sensor B.E.G. glass, wood

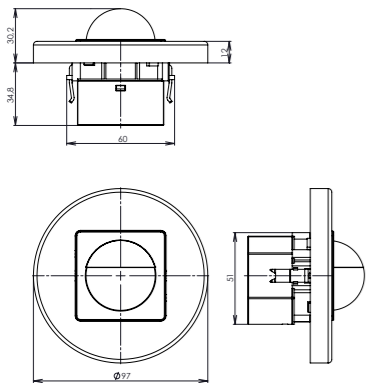

one level cam switch

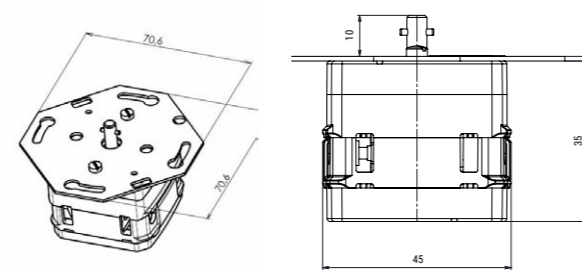

two level cam switch

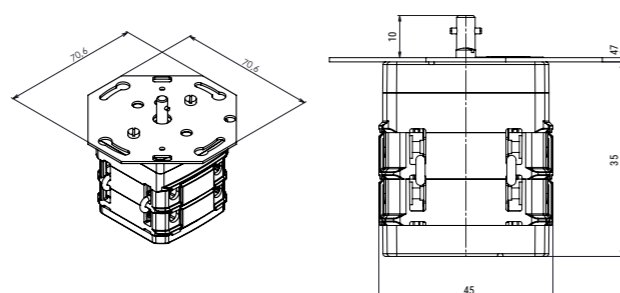

decente

frames

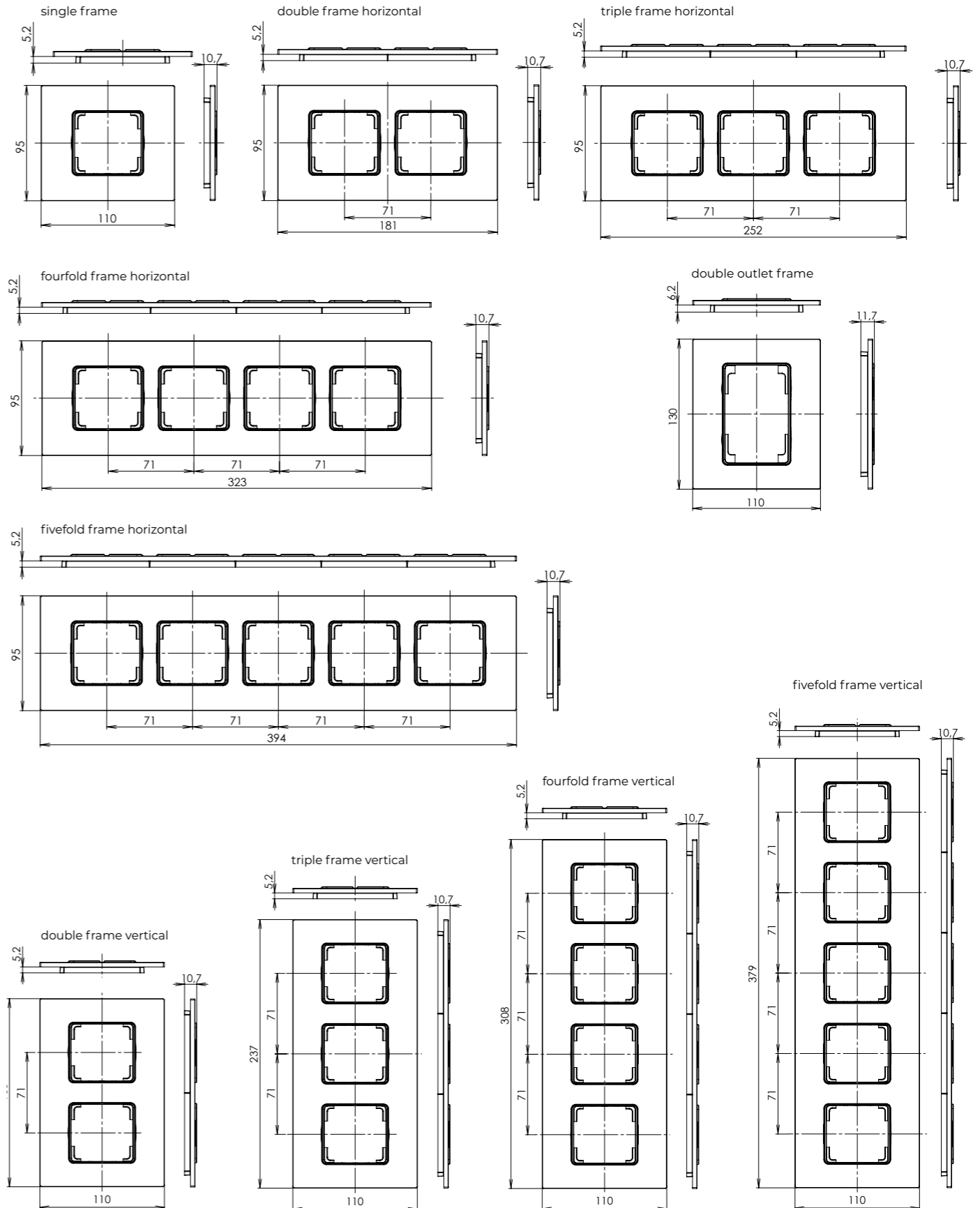

decente mini

frames

single frame

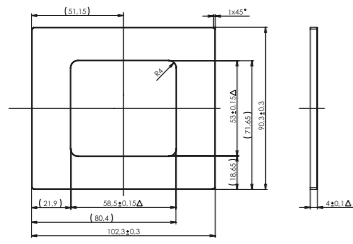

double frame horizontal

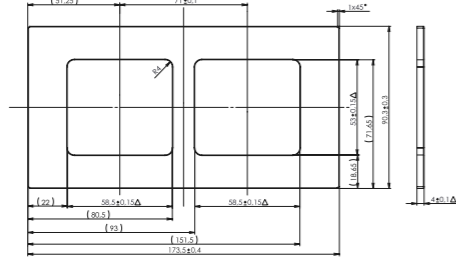

double outlet frame

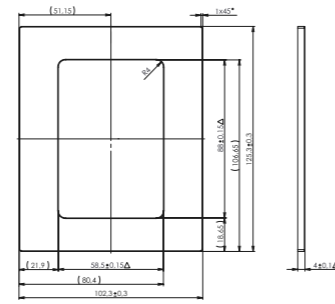

triple frame horizontal

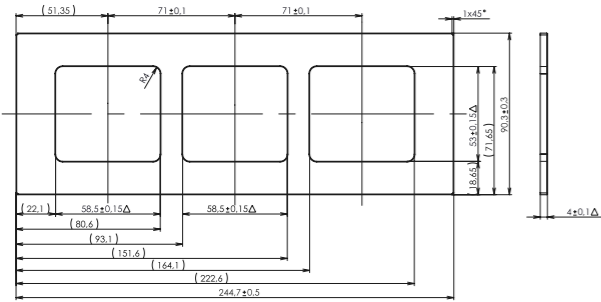

fourfold frame horizontal

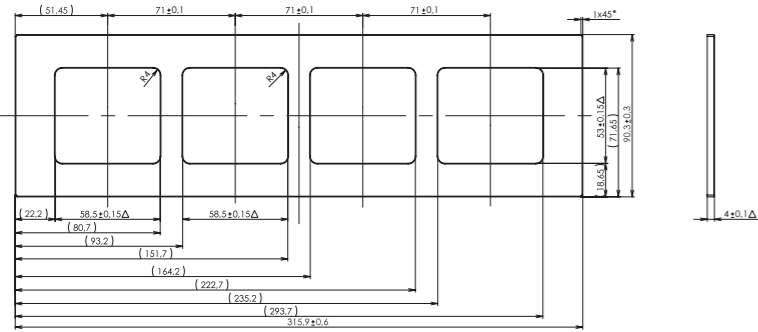

fivefold frame horizontal

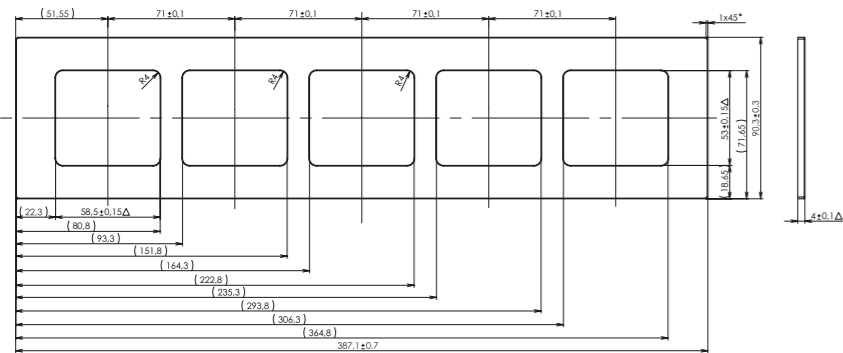

decente mini

frames

double frame vertical

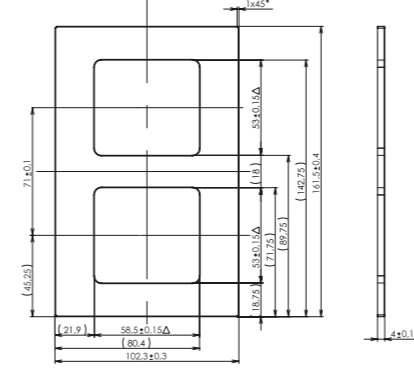

triple frame vertical

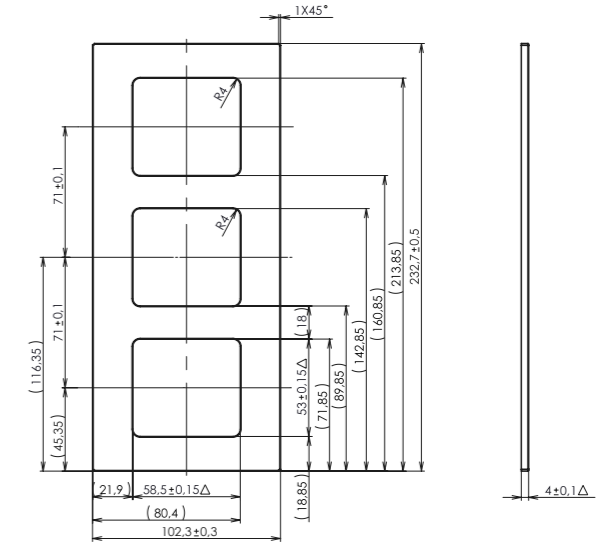

fourfold frame vertical

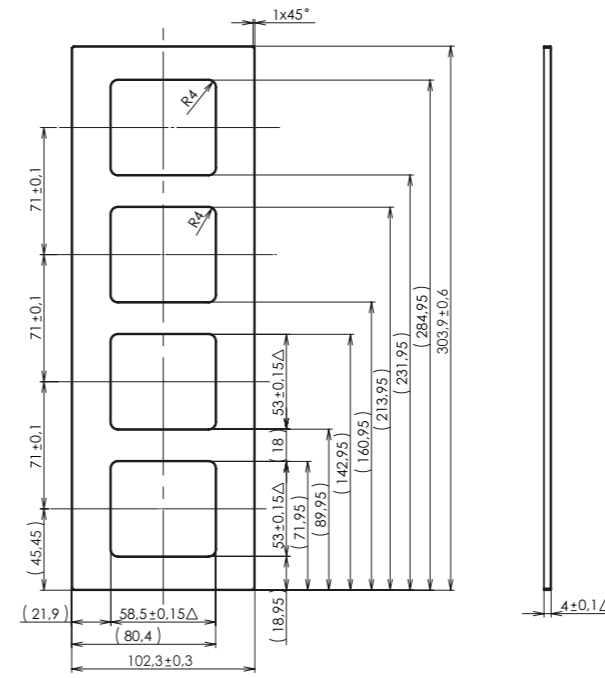

fivefold frame vertical

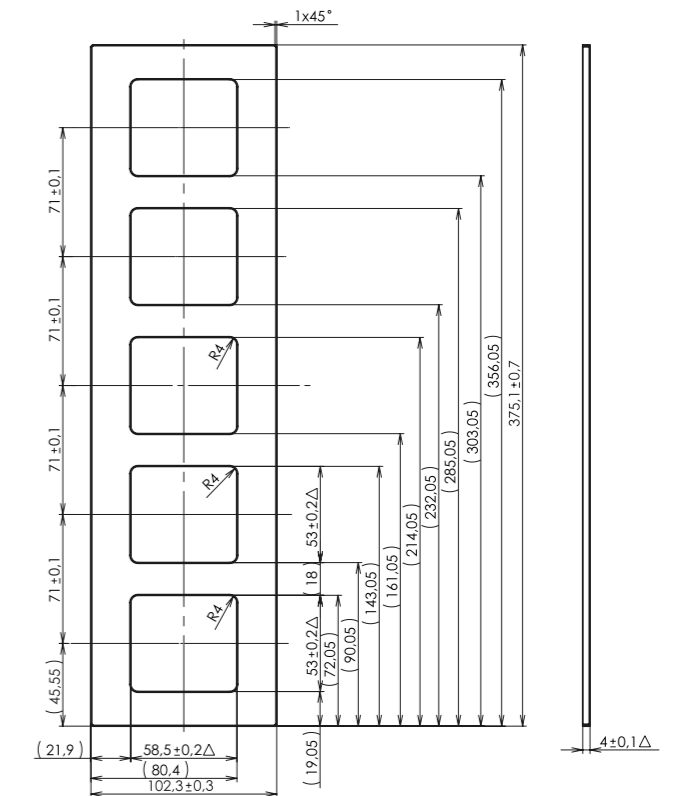

decente

fittings

switch with single cover

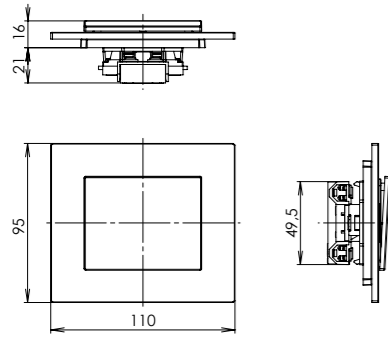

switch with single cover with backlighting

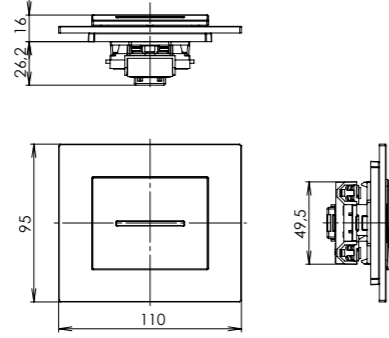

switch with double cover

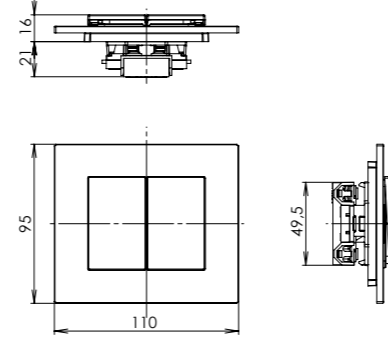

single sockets with safety shutters

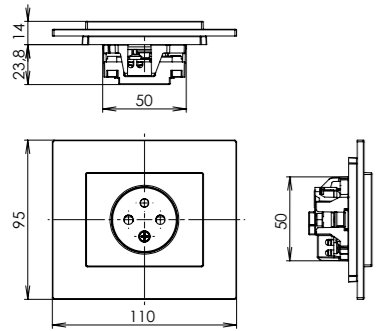

single sockets with safety shutters and overvoltage protection (light indication)

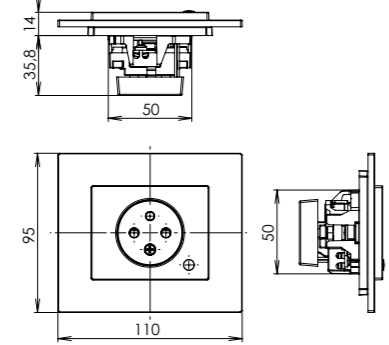

single sockets with safety shutters and overvoltage protection (audible alarm)

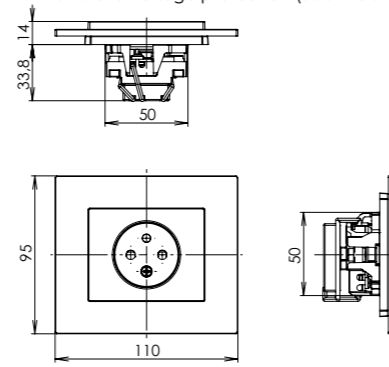

schuko single sockets with safety shutters

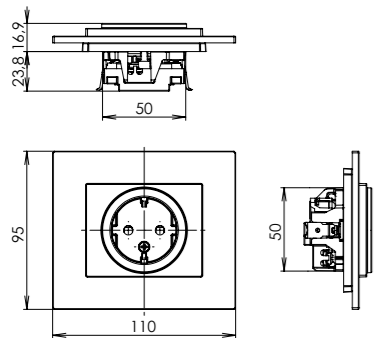

single sockets with safety shutters and overvoltage protection (light indication and audible alarm)

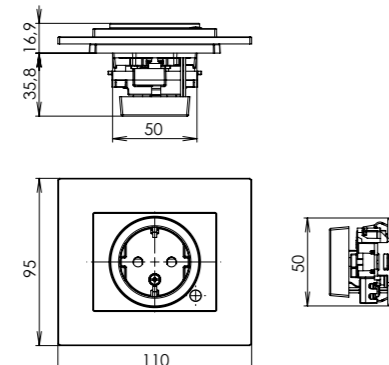

fittings for glass collection

single sockets with safety shutters

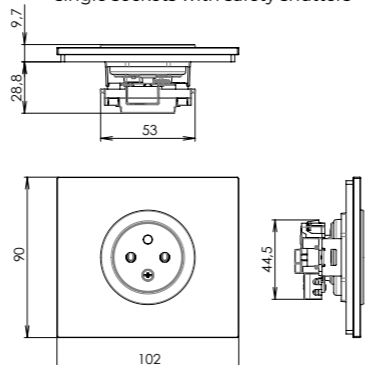

decente

fittings

double sockets with safety shutters

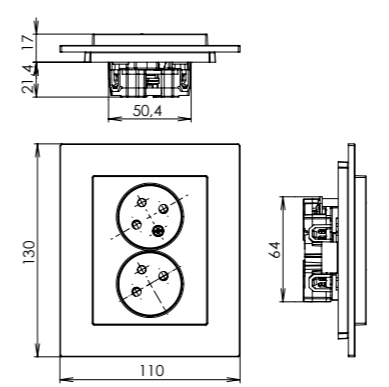

double sockets with safety shutters and overvoltage protection (audible alarm or light indication)

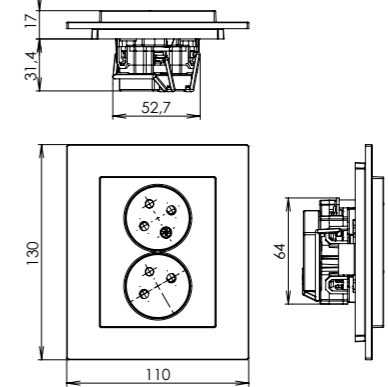

modular sockets USB with charger

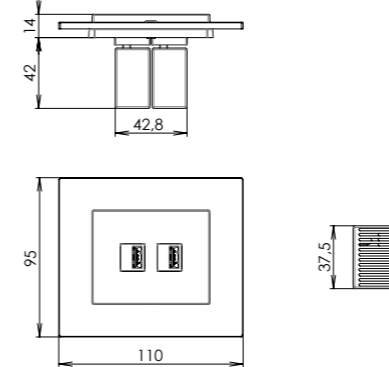

modular data sockets HDMI, USB, RJ45

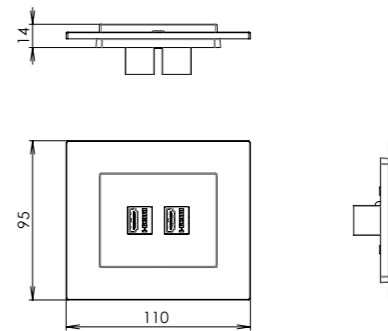

decente

fixtures

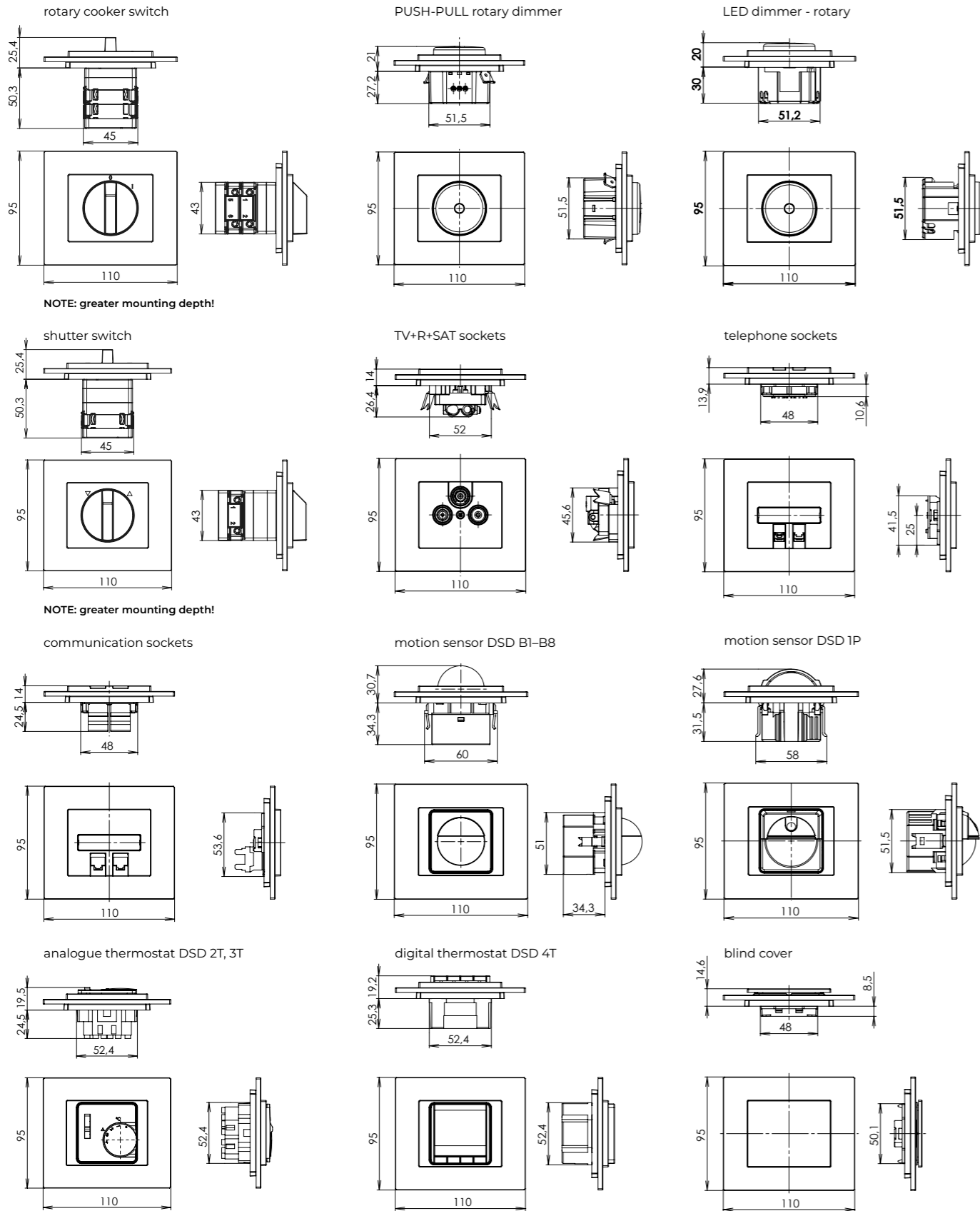

elegant

frames

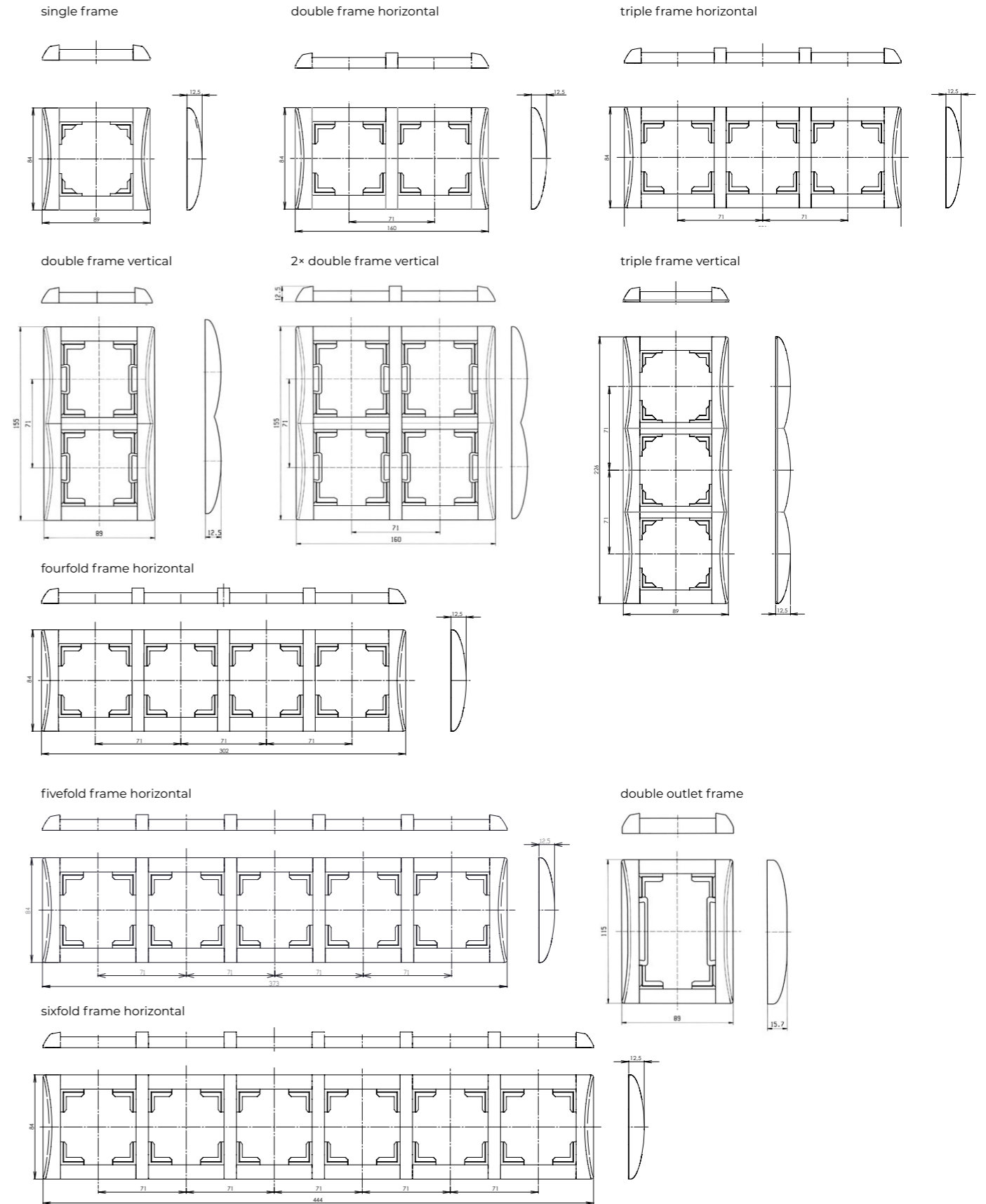

elegant

fittings

switch with single cover

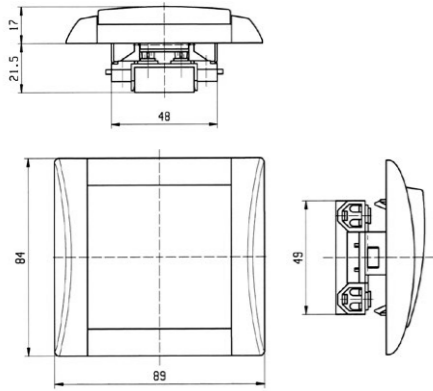

switch with double cover

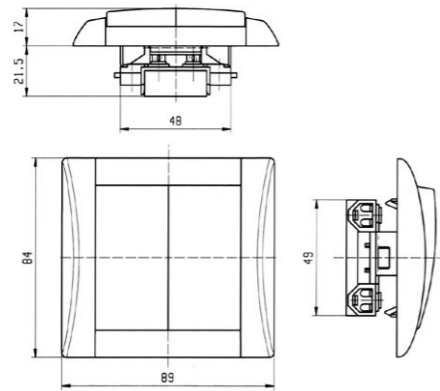

switch with triple cover

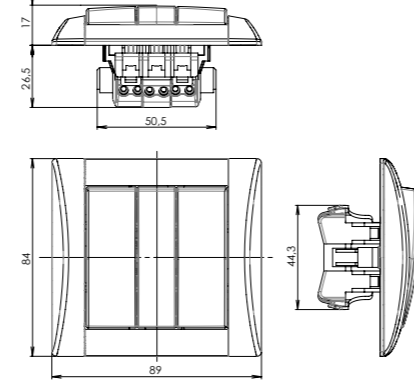

single sockets with/without safety shutters

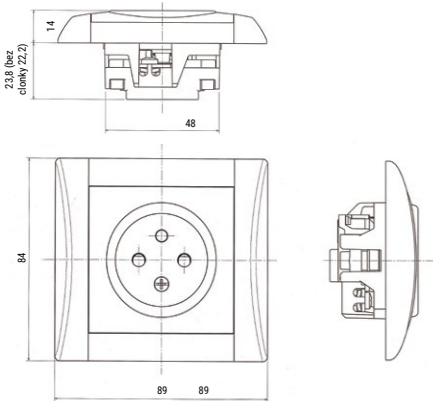

single sockets with overvoltage protection

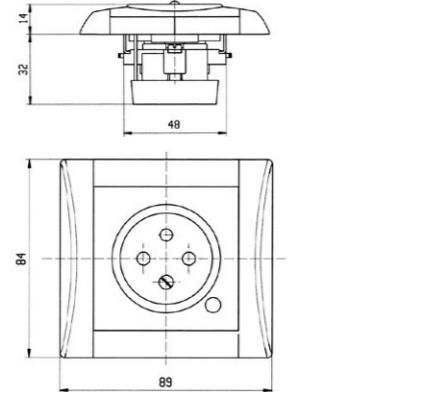

single schuko sockets

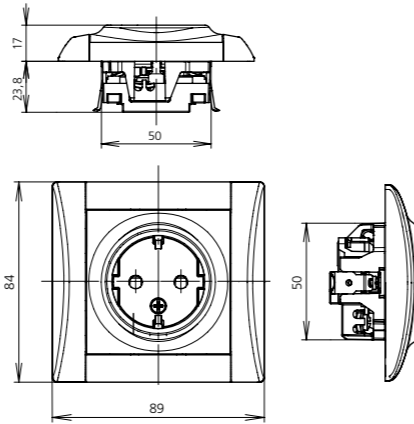

single schuko sockets with overvoltage protection (audible alarm)

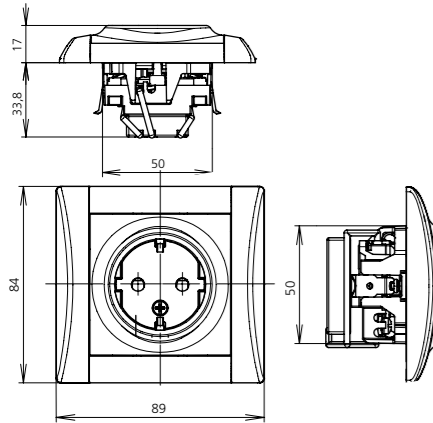

double sockets with/without safety shutters

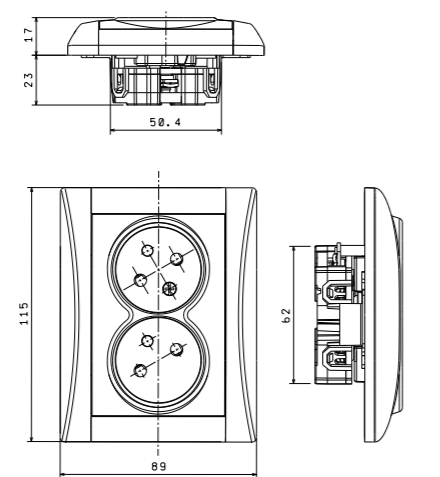

double sockets with overvoltage protection

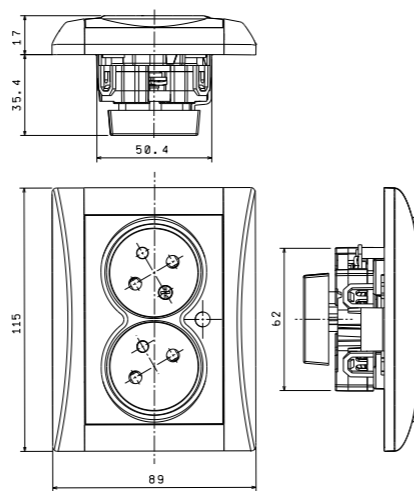

Double sockets must be installed in electrical installation no spout box at 6 and 12 o'clock.

elegant

fittings

IP 44 single sockets with a lid and safety shutters

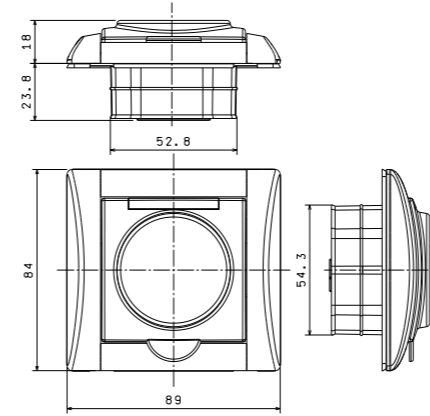

IP 44 switch with single cover

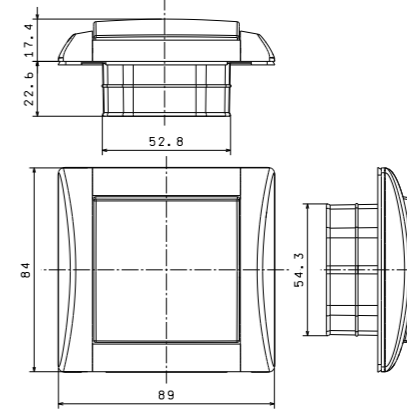

IP 44 switch with double cover

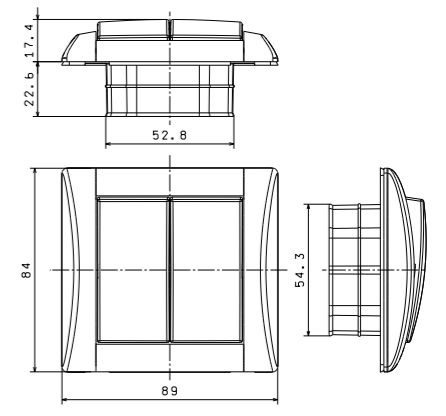

vacuum sockets

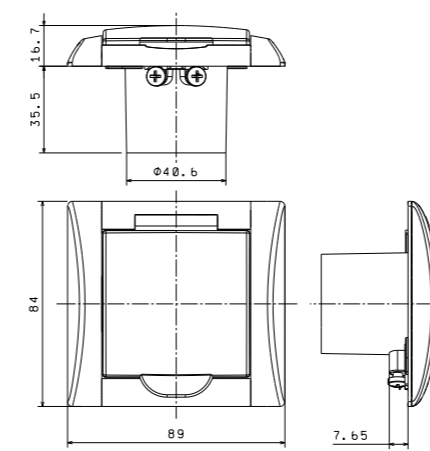

rotary cooker switch

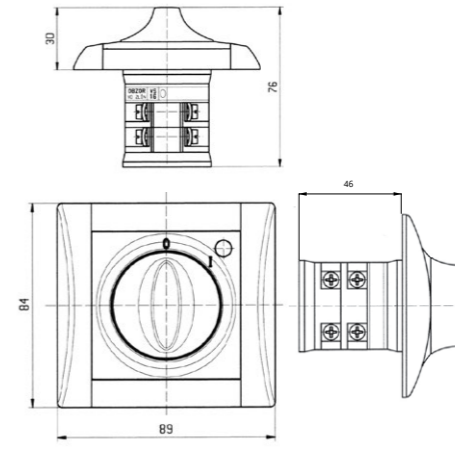

shutter controller

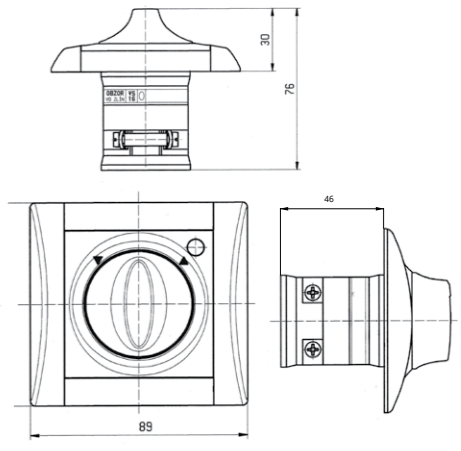

NOTE: greater mounting depth!

NOTE: greater mounting depth!

PUSH-PULL rotary dimmer switch

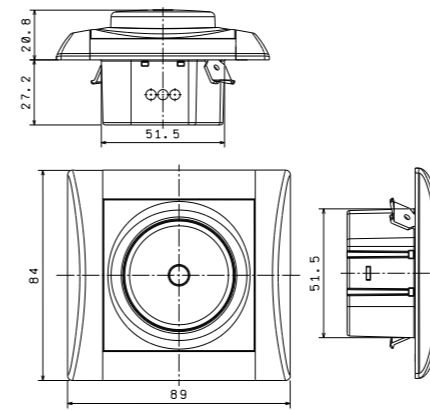

TV+R sockets

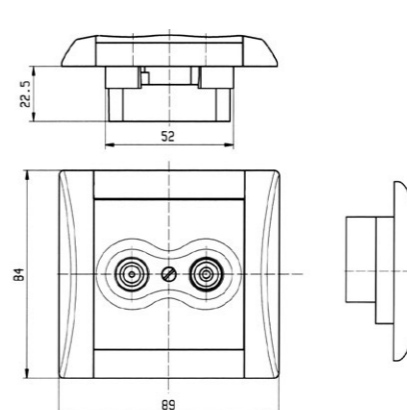

TV+R+SAT sockets

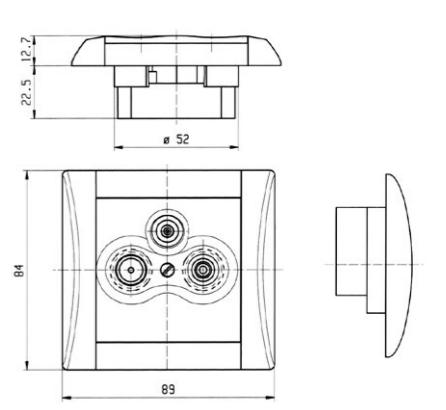

elegant

fittings

AUDIO-VIDEO sockets

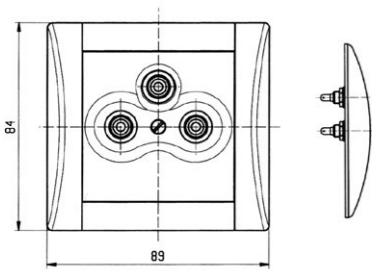
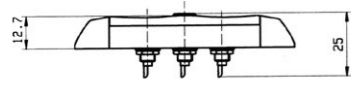

telephone sockets

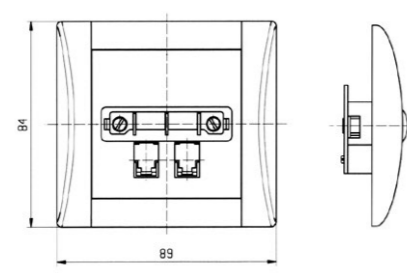
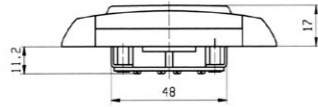

communication sockets

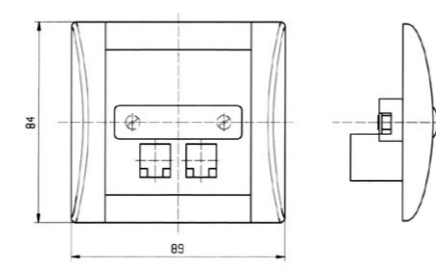
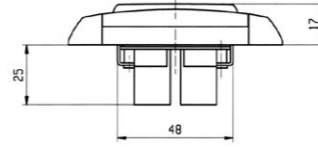

protective bonding sockets

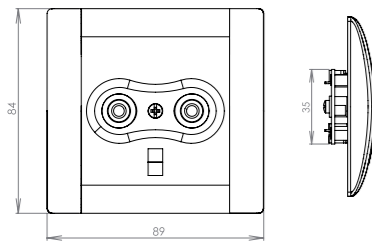
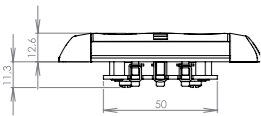

analog thermostat
OREG/EBERLE DSE 2T/3T

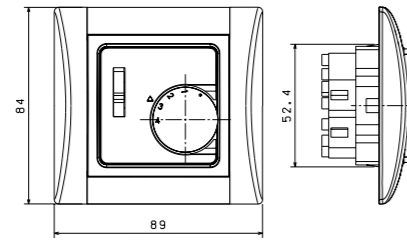
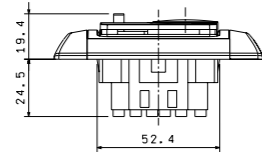

digital thermostat DSE 4T

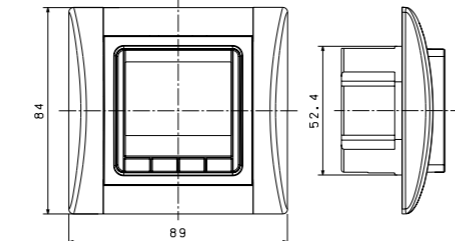
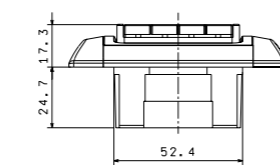

motion sensor STEINEL

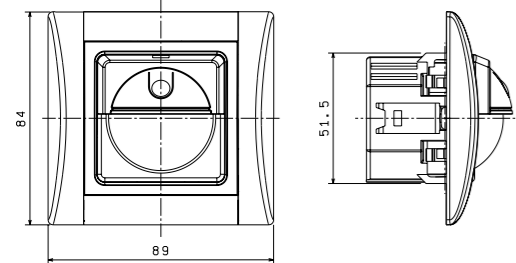
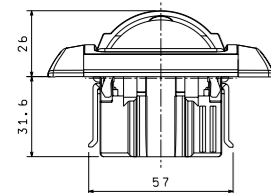

motion sensor B.E.G.

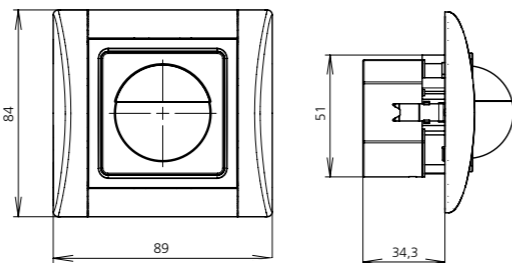
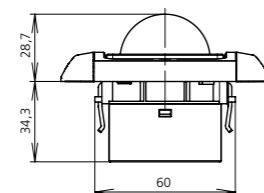

elegant

fittings

spacer ring VK1

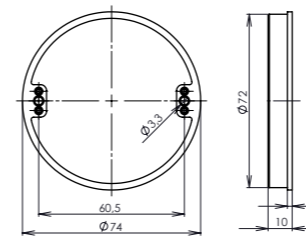

spacer ring VK2

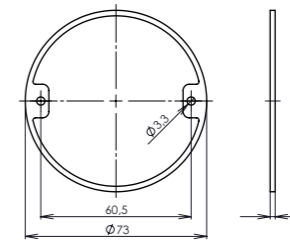

installation box, on-plaster

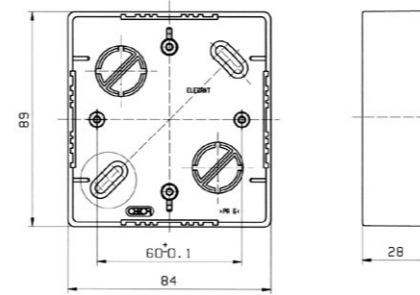

double sockets installation box,
on-plaster

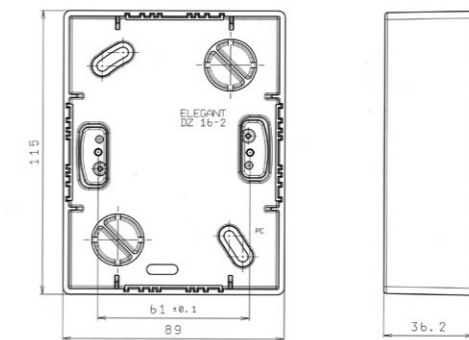

OBZOR



ESHOP

issue 01/2026, subject to change

OBZOR Zlín
Na Slanici 378
763 02 Zlín
Czech Republic

+420 577 195 138
+420 734 258 046
export@obzor.cz

obzorzlin.com
domovnivypinace.cz/en

